

GOVERNMENT OF MADHYA PRADESH

INDORE DUGHDH SANGHA SAHAKARI MARYADIT INDORE

FOR

Construction of Cover Shed of Washing Bay Platform in Main Dairy Plant Indore (M.P.)

Appendix 2.10 Tender Document

Percentage Rate Tender

NIT Number and Date : 1125/GMPO/2020

Agreement Number and Date : -----

Name of Work : Construction cover shed of Washing
bay Platform block District - Indore
(M.P.)

Name of the Contractor : _____

Probable Amount of Contract
(Rs. In Figure) : 7.00 Lakhs.

(Rs. In Words) : Seven lacs only

Contract Amount
(Rs. In Figure) : 7.00 Lakhs.

(Rs. In Words) : Seven lacs only

Stipulated Period of Completion : 1 Month

Appendix 2.10

Tender Document

Table of Contents

Section No	Particulars	Page
Section 1	NIT	
Section 2	Instructions to Bidders (ITB)	
	Bid Data Sheet	
	Annexure - A to M	
Section 3	Table of Clauses	
	Part - I General Conditions of Contract (GCC)	
	Contract Data	
	Annexure - N to W	
	Part - II Special Conditions of Contract (SCC)	
Section 4	Bill of Quantities (BOQ)	
Section 5	Agreement Form	

SECTION 1
Notice Inviting e-Tenders (short term)
Government of Madhya Pradesh

N.I.T. No. :1125/GMPO/2020

(Indore) , Dated 13-01-2020

Online percentage rates (As per MPPWD Building SOR amended up to tender date.) bids for the following work are invited from contractors and firms fulfilling registration criteria:

S. No./Pkg/Code	Name of Work	District(s)	Probable Amount (Rs. in lakh)	Completion Period (months)
1	Construction cover shed of Washing bay Platform District - Indore (M.P.)	(Indore)	7.00	1 Months

1. The interested bidders may view the Detailed Notice Inviting Tender on www.mpcdf.gov.in , purchase & submit tender on website <http://mptenders.gov.in>
2. The bid documents can be purchased online up to **1:30 PM of 22-01-2020.**
3. The bid documents can be submitted online up to **2:30 PM of 22-01-2020.**
4. Amendments to this NIT would be published on website only, and not in news papers.

Chief Executive Officer
Indore Dugdha Sangh Indore

NOTICE INVITING TENDER (short term)
Government of Madhya Pradesh
INDORE SAHAKARI DUGDHA SANGH MARYADIT INDORE

N.I.T. No 1125/GMPO/2020

dated 13-01-2020

Online percentage rate bids for the following works are invited from registered contractors and firms of repute fulfilling registration criteria:

S. No.	Name of Work	Probable Amount of Contract (Rs. in Lacs.)	Earnest Money Deposit (EMD) (In Rup.)	Cost of Bid Document (In Rupees)	Category of Contractor Centralized registration in MPPWD	Period of Completion (in Months)
1.	Construction cover shed of Washing bay Platform District - Indore (M.P.)	7.00	14000	1000	C & above	1 Months

1. All details relating to the Bid Document(s) can be viewed and downloaded free of cost on the website <http://www.mptenders.gov.in>
2. Bid Document can be purchased after making online payment of portal fees through Credit/Debit/Cash Card/internet banking.
3. At the time of submission of the Bid the eligible bidder shall be required to:
 - i) Pay the cost of Bid Document- Receipt
 - ii) Deposit the Earnest Money - Receipt
 - iii) Submit a check list with proper index and
 - iv) Submit an affidavit.
 Details can be seen in the Bid Data Sheet

4. ELIGIBILITY FOR BIDDERS:

(a) At the time of submission of the Bid the bidder should have valid registration with the Government of Madhya Pradesh, PWD in appropriate class. However, such bidders who are not registered with the Government of Madhya Pradesh and are eligible for registration can also submit their bids after having applied for registration with appropriate authority.

- Bidder should be submit GST return copy of previous quarter/Month/year
- Bidder should be submit EPF of his employees of last three months.
- Bidder should be submit copy of valid MPPWD registration, PAN , GST,EPF and above required documents and also submit documents as specified in tender document.

(b) The bidder would be required to have valid registration at the time of signing of the Contract.

(c) Failure to sign the contract by the selected bidder, for whatsoever reason, shall

result in forfeiture of the earnest money deposit.

5. **Pre-qualification** – Prequalification conditions, wherever applicable, are given in the Bid Data Sheet.
6. **Special Eligibility** – Special Eligibility Conditions, if any, are given in the Bid Data Sheet.
7. The Bid Document can be purchased only online up to **1:30 PM of 22-01-2020** . Other key dates may be seen in bid data sheet.
8. Amendments to NIT, if any, would be published on website only, and not in newspaper.

**Chief Executive Officer
Indore dugdha sangh indore**

SECTION 2

INSTRUCTIONS TO BIDDERS (ITB)

A. GENERAL

1. SCOPE OF BID

The detailed description of work, hereinafter referred as 'work', is Construction of washing bay platform at ISDSM INDORE District – Indore (M.P.). The initial period of 1 years after completion shall be treated as Defect Liability Period (DLP).

2. GENERAL QUALITY OF WORK:

The work shall have to be executed in accordance with the technical specifications specified in the Bid Data sheet/ Contract Data, and shall have to meet high standards of workmanship, safety and security of workmen and works.

3. PROCEDURE FOR PARTICIPATION IN E-TENDERING

The procedure for participation in e-tendering is given in the Bid Data Sheet.

4. ONE BID PER BIDDER

4.1 The bidder can be an individual entity or a joint venture (if permitted as per Bid Data Sheet). In case the J.V. is permitted, the requirement of joint venture shall be as per the Bid Data Sheet.

4.2 No bidder shall be entitled to submit more than one bid whether jointly or severally. If he does so, all bids wherein the bidder has participated shall stand disqualified.

4.3 In case of Bid submitted by the Joint Venture only lead member should be essentially registered in appropriate class of Registration with the Government of Madhya Pradesh or registered with Central Government / State Government / PSUs but The lead member would be required to have valid registration with MPPWD in appropriate class at the time of signing of the Contract.

5. Cost of Bidding

The bidder shall bear all costs associated with the preparation and submission of his bid, and no claim whatsoever for the same shall lie on the Government.

6. Site Visit and examination of works

The bidder is advised to visit and inspect the Site of Works and its surroundings and obtain for itself on its own responsibility all information that may be necessary for preparing the bid and entering into a contract for construction of the work. All costs in this respect shall have to be borne by the bidder.

B. Bid Documents

7. CONTENT OF BID DOCUMENTS

The Bid Document comprises of the following documents:

1. NIT with all amendments

2. Instructions to Bidders, Bid Data Sheet with all Annexures

3. Conditions of Contract:

- i. Part I General Conditions of Contract and the Contract Data with all Annexures;
and
- ii. Part II Special Conditions of Contract.

4. Specifications

5. Drawings

6. Priced Bill of Quantities

7. Technical and Financial Bid

8. Letter of Acceptance

9. Agreement, and

10. Any other document(s), as specified.

8. The bidder is expected to examine carefully all instructions, conditions of contract, the contract data, forms, terms and specifications, bill of quantities, forms and drawings in the Bid Document. Bidder shall be solely responsible for his failure to do so.

9. **PRE-BID MEETING**

Wherever the Bid Data Sheet provides for pre-bid meeting:

- 9.1 Details of venue, date and time would be mentioned in the Bid Data Sheet. Any change in the schedule of pre-bid meeting would be communicated on the website only, and intimation to bidders would not be given separately.
- 9.2 Any prospective bidder may raise his queries and/or seek clarifications in writing before or during the pre-bid meeting. The purpose of such meeting is to clarify issues and answer questions on any matter that may be raised at that stage. The Employer may, at his option, give such clarifications as are felt necessary.
- 9.3 Minutes of the pre-bid meeting including the gist of the questions raised and the responses given together with any response prepared after the meeting will be hosted on the website.
- 9.4 Pursuant to the pre-bid meeting if the Employer deems it necessary to amend the Bid Document, it shall be done by issuing amendment to the online NIT.

10. **AMENDMENT OF BID DOCUMENTS**

- 10.1 Before the deadline for submission of bids, the Employer may amend or modify the Bid Documents by publication of the same on website.
- 10.2 All amendments /corrigendum's shall form part of the Bid Document.
- 10.3 The Employer may, at its discretion, extend the last date for submission of bids by publication of the same on the website.

C. Preparation of Bid

11. The bidders have to prepare their bids online, encrypt their Bid Data in the Bid Forms and submit Bid Seals (Hashes) of all the envelopes and documents related to the Bid required to be uploaded as per the time schedule mentioned in the key dates of the Notice Inviting e-Tenders after signing of the same by the Digital Signature of their authorized representative.

12. DOCUMENTS COMPRISING THE BID

The bid submitted online by the bidder shall be in the following parts:

Part 1 – This shall be known as Online **Envelope A** and would apply for all bids. Online **Envelope A** shall contain the following as per details given in the Bid Data Sheet:

- i) Registration number or proof of application for registration and organizational details in format given in the Bid Data Sheet.
- ii) Payment of the cost of Bid Document;
- iii) Earnest Money; and
- iv) An affidavit duly notarized.

Part 2 – This shall be known as Online **Envelope B** and required to be submitted only in works where pre-qualification conditions and/or special eligibility conditions are stipulated in the Bid Data Sheet. Online **Envelope B** shall contain a self-certified sheet duly supported by documents to demonstrate fulfillment of pre-qualification conditions.

Part 3 – This shall be known as Online **Envelope C** and would apply to all bids. **Envelope C** shall contain financial offer in the prescribed format enclosed with the Bid Data Sheet.

13. LANGUAGE

The bid as well as all correspondence and documents relating to the bid exchanged by the Bidder and the Employer shall be in English. Supporting documents and printed literature that are part of the Bid may be in another language provided they are accompanied by an accurate translation of the relevant passages in English. In such case, for the purposes of interpretation of the bid, such translation shall govern.

14. TECHNICAL PROPOSAL

14.1 Only, in case of bids with pre-qualification conditions defined in the Bid Data Sheet, the Technical Proposal shall comprise of formats and requirements given in the Bid Data Sheet.

14.2 All the documents/ information enclosed with the Technical Proposal should be self-attested and certified by the bidder. The Bidder shall be liable for forfeiture of his earnest money deposit, if any document / information are found

false/ fake/ untrue before acceptance of bid. If it is found after acceptance of the bid, the bid sanctioning authority may at his discretion forfeit his performance security/ guarantee, security deposit, enlistment **deposit** and take any other suitable action.

15. FINANCIAL BID

- i. The bidder shall have to quote rates in format referred in Bid Data Sheet, in overall percentage, and not item wise. If the bid is in absolute amount, overall percentage would be arrived at in relation to the probable amount of contract given in NIT. The overall percentage rate would apply for all items of work.
- ii. Percentage shall be quoted in figures as well as in words. If any difference in figures and words is found, lower of the two shall be taken as valid and correct.
- iii. The bidder shall have to quote rates inclusive of all duties, taxes, royalties and other levies; and the Employer shall not be liable for the same.
- iv. The material along with the units and rates, which shall be issued, if any, by the department to the contractor, is mentioned in the Bid Data Sheet.

16. PERIOD OF VALIDITY OF BIDS

The bids shall remain valid for a period specified in the Bid Data Sheet after the date of “close for bidding” as prescribed by the Employer. The validity of the bid can be extended by mutual consent in writing.

17. EARNEST MONEY DEPOSIT (EMD)

- 17.1** The Bidder shall furnish, as part of the Bid, Earnest Money Deposit (EMD), in the amount specified in the Bid Data Sheet.
- 17.2** The EMD shall be deposit by bidder in online mode only on portal of tender purchase and submit.
- 17.3** Bid not accompanied by EMD shall be liable for rejection as non-responsive.
- 17.4** EMD of bidders whose bids are not accepted will be returned within ten working days of the decision on the bid.
- 17.5** EMD of the successful Bidder will be discharged when the Bidder has signed the Agreement after furnishing the required Performance Security.
- 17.6** Failure to sign the contract by the selected bidder, within the specified period, for whatsoever reason, shall result in forfeiture of the earnest money deposit.

D. Submission of Bid

- 18.** The bidder is required to submit online bid duly signed digitally, and Envelop ‘A’ in physical form also at the place prescribed in the Bid Data Sheet.

E. Opening and Evaluation of Bid

19 PROCEDURE

- 19.1** Envelope ‘A’ shall be opened first online at the time and date notified and its

contents shall be checked. In cases where Envelop 'A' does not contain all requisite documents, such bid shall be treated as non-responsive, and Envelop B and/or C of such bid shall not be opened.

- 19.2** Wherever Envelop 'B' (Technical Bid) is required to be submitted, the same shall be opened online at the time and date notified. The bidder shall have freedom to witness opening of the Envelop 'B'. Envelop 'C' (Financial Bid) of bidders who are not qualified in Technical Bid (Envelop 'B') shall not be opened.
- 19.3** Envelope 'C' (Financial Bid) shall be opened online at the time and date notified. The bidder shall have freedom to witness opening of the Envelop 'C'.
- 19.4** After opening Envelop 'C' all responsive bids shall be compared to determine the lowest evaluated bid.
- 19.5** The Employer reserves the right to accept or reject any bid, and to annul the bidding process and reject all the bids at any time prior to contract award, without incurring any liability. In all such cases reasons shall be recorded.
- 19.6** The Employer reserves the right of accepting the bid for the whole work or for a distinct part of it.

20. Confidentiality

- 20.1** Information relating to examination, evaluation, comparison and recommendation of contract award shall not be disclosed to bidders or any other person not officially concerned with such process until final decision on the bid.
- 20.2** Any attempt by a bidder to influence the Employer in the evaluation of the bids or contract award decisions may result in the rejection of his bid.

F. Award of Contract

21. Award of Contract

The Employer shall notify the successful bidder by issuing a 'Letter of Acceptance' (LOA) that his bid has been accepted.

22. Performance Security

- 22.1** Prior to signing of the Contract the bidder to whom LOA has been issued shall have to furnish performance security of the amount in the form and for the duration, etc. as specified in the Bid Data Sheet.
- 22.2** Additional performance security, if applicable, is mentioned in the Bid Data Sheet and shall be in the form and for the duration etc. similar to Performance Security.

23. Signing of Contract Agreement

- 23.1** The successful bidder shall have to furnish Performance Security and Additional Performance Security, if any, and sign the contract agreement within 15 days of issue of LOA.

23.2 The signing of contract agreement shall be reckoned as intimation to commencement of work. No separate work order shall be issued by the Employer to the contractor for commencement of work.

23.3 In the event of failure of the successful bidder to submit Performance Security and Additional Performance Security, if any or sign the Contract Agreement, his EMD shall stand forfeited without prejudice to the right of the employer for taking any other action against the bidder.

24. CORRUPT PRACTICES

The Employer requires that bidders observe the highest standard of ethics during the procurement and execution of contracts. In pursuance of this policy, the Employer:

- i. may reject the bid for award if it determines that the bidder recommended for award has, directly or through an agent, engaged in corrupt, fraudulent, collusive, or coercive practices in competing for the Contract; and
- ii. may debar the bidder declaring ineligible, either indefinitely or for a stated period of time, to participate in bids, if it at any time determines that the bidder has, directly or through an agent, engaged in corrupt, fraudulent, collusive or coercive practices in competing for, or in executing, a contract.

For the purposes of this provision, the terms set forth above are defined as follows:

- a. “corrupt practice” means the offering, giving, receiving, or soliciting, directly or indirectly, anything of value to influence improperly the actions of another party;
- b. “fraudulent practice” means any act or omission, including a misrepresentation, that knowingly or recklessly misleads, or attempts to mislead, a party to obtain a financial or other benefit or to avoid an obligation;
- c. “coercive practice” means impairing or harming, or threatening to impair or harm, directly or indirectly, any party or the property of the party to influence improperly the actions of a party;
- d. “collusive practice” means an arrangement between two or more parties designed to achieve an improper purpose, including influencing improperly the actions of another party.

[End of ITB]

Bid Data Sheet

GENERAL		
SR. No.	PARTICULARS	DATA
1	Office inviting tender	Chief Executive Officer Indore Sahakari Dugdh Sangh Maryadit Indore
2	NIT No	1125/GMPO/2020
3	Date of NIT	16-01-2020
4	Bid document download available up to date & time	22-01-2020 1:30 PM
5	Website link	http:// www.mptenders.gov.in
SECTION 1 – NIT		
CLAUSE REFERENCE	PARTICULARS	DATA
2	Portal fees	
3	Cost of bid document	As per Norms
	Cost of bid document Payable at	Online
	Cost of bid document In favor of	Online
4	Affidavit format	Annexure B
5	Pre-qualifications required	YES
	If Yes, details	Annexure C
6	Special Eligibility	NO
	If Yes, details	Annexure D
	Key dates	Annexure A
SECTION 2 - ITB		
CLAUSE REFERENCE	PARTICULARS	DATA
1	Name of 'work'	Construction cover shed of Washing bay Platform District - Indore (M.P.)
2	Specifications	Annexure – E
3	Procedure for participation in e-tendering	Annexure – F
4	Whether Joint Venture is allowed	YES
	Pre bid meeting to be held	YES
9	If Yes, Date, Time & Place	Date : 20-01-2020 Time from: 2:30 pm

Bid Data Sheet

CLAUSE REFERENCE	PARTICULARS	DATA
12	Envelope-A containing : i. Registration number or proof of application for registration and organizational details as per Annexure H ii. Cost of Bid Document iii. EMD iv. An affidavit duly notarized as per Annexure - B should reach in physical form	
14	Envelope-B Technical Proposal	Annexure - I and Annexure - I (Format I-1 to I-5)
15	Envelope-C Financial Bid	Annexure - J
	Materials to be issued by the department	Not Applicable
16	Period of Validity of Bid	120 Days
	Earnest Money Deposit	Rs.14000
	Forms of Earnest Money Deposit	Only online on portal
17	EMD valid for a period of	Six Months after the last date of receipt of bids
	FDR must be drawn in favour of	Chief Executive Officer Indore Sahkari Dugdh sangh Maryadit Indore
21	Letter of Acceptance (LOA)	Annexure L
	Amount of Performance Security	5% of contract amount
	Additional Performance Security, if any	NIL
22	Performance security in the format	Annexure M
	Performance security in favor of	Chief Executive Officer Indore Sahakari Dugdh sangh Maryadit Indore
	Performance security valid up to	Valid Contract period plus 3 months

Annexure – A
(See clause 1, 7 of Section 1 -NIT)

KEY DATES

Purchase of Tender Start Date :	16-01-2020 1:00 pm	Pre-bid meeting Date and Time:	20-01-2020 2:30 pm
Purchase of Tender End Date:	22-01-2020 1:30 pm	Online Bid Submission End Date:	22-01-2020 2:30pm
Physical Bid Submission End Date:	22-01-2020 2:30pm	Envelope-A Open Date:	23-01-2020 2:30pm
Envelope-B(Technical Bid) Open Date:	23-01-2020 3:00pm	Envelope-C (Financial Bid) Open Date:	After scrutiny of technical bid

Original term deposit receipt of earnest money deposit, cost of bid document, experience certificate and affidavit and all required document as per qualification criteria and mentioned in pre qualification criteria (Annexure -c) shall be submitted physically by the bidder so as to reach the office as prescribed in Bid Data Sheet, at least one calendar day before specified start time and date in key dates for opening of technical proposal as per Key dates in Bid Data Sheet.

(See clause 3 of Section 1 -NIT)

|| AFFIDAVIT ||

(To be contained in Envelope A)

(On Non Judicial Stamp of Rs. 100)

I/we _____ who is/ are _____ (status in the firm/ company) and competent for submission of the affidavit on behalf of M/S _____ (contractor) do solemnly affirm an oath and state that:

I/we am/are fully satisfied for the correctness of the certificates/records submitted in support of the following information in bid documents which are being submitted in response to notice inviting e-tender No. _____ for _____ (name of work) dated _____ issued by the _____ (name of the department).

I/we am/are fully responsible for the correctness of following self-certified information/ documents and certificates:

1. That the self-certified information given in the bid document is fully true and authentic.
2. That:
 - a. Term deposit receipt deposited as earnest money, demand draft for cost of bid document and other relevant documents provided by the Bank are authentic.
 - b. Information regarding financial qualification and annual turnover is correct.
 - c. Information regarding various technical qualifications is correct.
3. No close relative of the undersigned and our firm/ company is working in the department.

OR

Following close relatives are working in the department:

Name _____ Post _____ Present Posting _____

Signature with Seal of the Deponent (bidder)

I/ We, _____ above deponent do hereby certify that the facts mentioned in above paras 1 to 4 are correct to the best of my knowledge and belief.

Verified today _____ (dated) at _____ (place).

Signature with Seal of the Deponent (bidder)

Note: Affidavit duly notarized in original shall reach at least one calendar day before opening of the bid.

PRE-QUALIFICATIONS CRITERIA

The bidder should have:

A. Financial

- i. Experience of having successfully executed as prime contractor:
 - a) three similar works each costing not less than the amount equal to 20% of the probable amount of contract during the last 5 financial years; or
 - b) two similar works each costing not less than the amount equal to 30% of the probable amount of contract during the last 5 financial years; or
 - c) one similar work of aggregate cost not less than the amount equal to 50% of the probable amount of contract during the last 5 financial years;

Note:- Certificate issued by the Principal Employer should be submitted for each completed similar work.

The Similar work shall include Dugdh dairy Project / Govt. Industrial/ Office Building /Administrative Building or Institutional Project having built-up area of at least 100 square meter.

- ii. The Bidder shall have completed all the civil work related with the Mechanical Machinery and plant work
- iii. Average annual construction turnover on the construction works not less than 100% of the probable amount of contract during the last 3 financial years.
- iv. Bidder should be submit GST return copy of previous quarter/Month/year
- v. Bidder should be submit EPF of his employees of last three months.
- vi. Bidder should be submit copy of valid MPPWD registration, PAN , GST,EPF and above required documents and also submit documents as specified in tender document.

Annexure – D

(See clause 6 of Section 1 -NIT)

SPECIAL ELIGIBILITY CRITERIA

The bidder should have experience of:

NIL

SPECIFICATIONS

1. PWD, Specification / SOR 2014, amended up to date of NIT
2. CPWD, Specifications, amended up to date of NIT.
3. National Building Code of India, amended up to date of NIT.
4. As per enclosed ANNEXURE – E1

(ANNEXURE - E1 Detailed
Specification Shall be enclosed
by concerned PWD as per
Project.)

The provisions of general / special conditions of contract, those specified elsewhere in the bid document, as well as execution drawings and notes, or other specifications issued in writing by the Employer shall form part of the technical specifications of this work.

Procedure for Participation in e-Tendering

1. Registration of Bidders on e-Tendering System:

All the PWD registered bidders are already registered on the new e-procurement portal [https:// www.mptenders.gov.in](https://www.mptenders.gov.in). The user id will be the contractor ID provided to them from MP Online. The password for the new portal has been sent to the bidders registered email ID.

2. Digital Certificate:

The bids submitted online should be signed electronically with a Class III Digital Certificate to establish the identity of the bidder submitting the bid online. The bidders may obtain Class III Digital Certificate issued by an approved Certifying Authority authorized by the Controller of Certifying Authorities, Government of India. A Class III Digital Certificate is issued upon receipt of mandatory identity proofs along with an application. Only upon the receipt of the required documents, a Digital Certificate can be issued. For details please visit cca.gov.in.

Note:

- i. It may take upto 7 working days for issuance of Class-III Digital Certificate; hence the bidders are advised to obtain the certificate at the earliest. Those bidders who already have valid Class-III Digital Certificate need not obtain another Digital Certificate for the same.*
The bidders may obtain more information and the Application Form required to be submitted for the issuance of Digital Certificate from cca.gov.in
- ii. Bids can be submitted till bid submission end date. Bidder will require digital signature while bid submission.*

The digital certificate issued to the Authorized User of a Partnership firm / Private Limited Company / Public Limited Company and used for online bidding will be considered as equivalent to a no-objection certificate / power of attorney to that user.

In case of Partnership firm, majority of the partners have to authorize a specific individual through Authority Letter signed by majority of the partners of the firm. In case of Private Limited Company, Public Limited Company, the Managing Director has to authorize a specific individual through Authority Letter. Unless the certificate is revoked, it will be assumed to represent adequate authority of the specific individual to bid on behalf of the organization for online bids as per information Technology Act 2000. This Authorized User will be required to obtain a Digital Certificate. The Digital Signature executed through the use of Digital Certificate of this Authorized User will be binding on the firm. It shall be the responsibility of Management / Partners of the concerned firm to inform the Certifying Authority, if the Authorized User changes, and apply for a fresh Digital Certificate for the new Authorized User.

3. Set Up of Bidder's Computer System:

In order for a bidder to operate on the e-tendering System, the Computer System of the

bidder is required to be set up for Operating System, Internet Connectivity, Utilities, Fonts, etc. The details are available at [https:// www.mptenders.gov.in](https://www.mptenders.gov.in)

4. Key Dates:

The bidders are strictly advised to follow the time schedule (Key Dates) of the bid on their side for tasks and responsibilities to participate in the bid, as all the stages of each bid are locked before the start time and date and after the end time and date for the relevant stage of the bid as set by the Department.

5. Preparation and Submission of Bids

The bidders have to prepare their bids online, encrypt their bid Data in the Bid forms and submit Bid of all the envelopes and documents related to the Bid required to be uploaded as per the time schedule mentioned in the key dates of the Notice inviting e-Tenders after signing of the same by the Digital Signature of their authorized representative.

6. Purchase of Bid Document

For purchasing of the bid document bidders have to pay Service Charge online ONLY which is Rs. [as per Bid Date Sheet]. Cost of bid document is separately mentioned in the Detailed NIT. The Bid Document shall be available for purchase to concerned eligible bidders immediately after online release of the bids and up to scheduled time and date as set in the key dates.

The payment for the cost of bid document shall be made online through Debit/ Credit card, Net banking or NEFT Challan through the payment gateway provided on the portal.

7. Withdrawal, Substitution and Modification of Bids

Bidder can withdraw and modify the bid till Bid submission end date.

Annexure - H

(See clause 12 of Section 2
–ITB & clause 4 of GCC)

ORGANIZATIONAL DETAILS

(To be Contained in Envelope - A)

S. No.	Particulars	Details
1.	Valid Registration of bidder in appropriate class through Centralized Registration of Government of MP	Registration No. _____ Date_____ (Scanned copy of Registration to be uploaded)
2.	Name of Organization/ Individual/ Proprietary Firm/ Partnership Firm	
3.	Entity of Organization Individual/ Proprietary Firm/ Partnership Firm (Registered under Partnership Act)/ Limited Company (Registered under the Companies Act 1956)/ COUNCIL/ Joint Venture	
4.	Address of Communication	
5.	Telephone Number with STD Code	
6.	Fax Number with STD Code	
7.	Mobile Number	
8.	E-mail Address for all communications	
	Details of Authorized Representative	
9.	Name	
10.	Designation	
11.	Postal Address	
12.	Telephone Number with STD Code	
13.	Fax Number with STD Code	
14.	Mobile Number	
15.	E-mail Address	

Note: In case of partnership firm and limited company certified copy of partnership deed/ Articles of Association and Memorandum of Association along with registration certificate of the company shall have to be enclosed.

Signature of Bidder with Seal

Date: _____

Annexure – I

(See clause 14 of Section 2 -ITB)

Envelope – B, Technical Proposal

Technical Proposal shall comprise the following documents:

S.No.	Particulars	Details to be submitted
1	Experience – Financial & Physical	Annexure - I (Format: I-1)
2	Annual Turnover	Annexure - I (Format: I-2)
3	List of technical personnel for the key positions	Annexure - I (Format: I-3)
4	List of Key equipments/ machines for quality control labs	Annexure - I (Format: I-4)

Note:

1. Technical Proposal should be uploaded duly page numbered and indexed.
2. Technical Proposal uploaded otherwise will not be considered.

FINANCIAL & PHYSICAL EXPERIENCE DETAILS

A. Financial

- i. Experience of having successfully executed as prime contractor:
 - a) three similar works, each costing not less than the amount equal to 20% of the probable amount of contract during the last 5 financial years; or
 - b) two similar works, each costing not less than the amount equal to 30% of the probable amount of contract during the last 5 financial years; or
 - c) one similar work of aggregate cost not less than the amount equal to 50% of the probable amount of contract during the last 5 financial years;

Note:- Certificate issued by the Principal Employer should be submitted for each completed similar work.

The Similar work shall include dugdh dairy Project / Govt. industrial building or Institutional Project having built-up area of at least 100 square meter.

The Bidder shall have completed all the civil work related with the Mechanical Machinery and plant work

- ii. Average annual construction turnover on the construction works not less than 100% of the probable amount of contract during the last 3 financial years.
- iii The Bidder shall have positive net-worth as per the audited Balance Sheet of last financial year.

B. Physical

To be filled in by the contractor:

- i. Details of successfully completed similar works shall be furnished in the following format.
- ii. Certificate duly signed by the employer shall also be enclosed for each completed similar work.
- iii. Duly self certified photographs and/or video of the completed works shall be attached in support of each completed similar work.

iv

Completed Similar Works

Agreement Number & Year	Name of Work	Date of Work Order	Date of Completion	Amount of Contract	Employer's Name and Address

ANNUAL TURN OVER

Requirement:

Average annual construction turnover on the construction works not less than 50% of the probable amount of contract during the last 3 financial years;

To be filled in by the contractor:

Financial Year	Payments received for contracts in progress or completed
1	
2	
3	

Note:

- i. Annual turnover of construction should be certified by the Chartered Accountant.
- ii. Audited balance sheet including all related notes, and income statements for the above financial years to be enclosed.

Annexure - I (Format: I-3)*(See clause 14 of Section 2 –ITB
& Clause 6 of GCC)***List of Technical Personnel for the Key Positions**

Minimum requirement						Available with the bidder					
S. No.	Key Position	Minimum requirement	Qualification	Similar work experience (years)	Total Work Experience (years)	S. No.	Name of Personnel	Key Position	Qualification	Similar work experience	Total Work Experience
1	Project In Charge	01	Graduate in civil Engineering	10	15						
2	Project Engineer	02	Graduate in civil Engineering	8	10						
3	Site Engineer	04	Diploma in civil Engineering	3	5						
4	Electrical Engineer	01	Graduate in Electrical Engineering	5	7						
5	Supervisor	08	12 th Passed	5	10						
6	Lab Technician	02	Diploma in Civil Engineering	5	7						
7	Quality Control	01	Graduate in civil Engineering	8	10						

List of Key Equipments/ Machines for Construction Work

Minimum requirement			Available with the bidder	
S. No.	Name of Equipment/ Machinery	Quantity	Name of Equipment/ Machinery	Quantity
1.	Excavator cum loader with sufficient number of dumpers / trucks	01 Nos.		
2.	Breakers	01 Nos.		
3.	Steel Shuttering	150 sq.m.		
4.	Needle Vibrators	1 Nos.		
5.	Table Vibrators	01 Nos.		
6.	Material Hoists	01 Nos.		

FINANCIAL BID
(To Be Contained in Envelope-C)

NAME OF WORK: Construction cover shed of Washing bay Platform at ISDSM Indore District - Indore (M.P.)

I/We hereby bid for the execution of the above work within the time specified at the **rate (in figures) _____ (in words) _____ percent below/ above or at par** based on the Bill of Quantities and item wise rates given therein in all respects and in accordance with the specifications, designs, drawings and instructions in writing in all respects in accordance with such conditions so far as applicable. I/We have visited the site of work and am/ are fully aware of all the difficulties and conditions likely to affect carrying out the work. I/We have fully acquainted myself / ourselves about the conditions in regard to accessibility of site and quarries/ kilns, nature and the extent of ground, working conditions including stacking of materials, installation of tools and plant conditions effecting accommodation and movement of labour etc. required for the satisfactory execution of contract.

Should this bid be accepted, I/We hereby agree to abide by and fulfill all the terms and provisions of the said conditions of contract annexed hereto so far as applicable, or in default thereof to forfeit and pay to the Governor of Madhya Pradesh or his successors in office the sums of money mentioned in the said conditions.

Note:

- i. Only one rate of percentage above or below or at par based on the Bill of Quantities and item wise rates given therein shall be quoted.
- ii. Percentage shall be quoted in figures as well as in words. If any difference in figures and words is found lower of the two shall be taken as valid and correct rate. If the bidder is not ready to accept such valid and correct rate and declines to furnish performance security and sign the agreement his earnest money deposit shall be forfeited.
- iii. In case the percentage "above" or "below" is not given by a bidder, his bid shall be treated as non-responsive.
- iv. All duties, taxes, and other levies payable by the bidder shall be included in the percentage quoted by the bidder.

Signature of Bidder Name of Bidder

The above bid is hereby accepted by me on behalf of the Governor of Madhya Pradesh dated the _____ day of _____ 20__

Signature of Officer by whom accepted

MATERIALS TO BE ISSUED BY THE DEPARTMENT

S. No.	Name of material	Rate (Issue rate)	Unit	Remarks

NOT APPLICABLE

LETTER OF ACCEPTANCE (LOA)

No.: _____

Dated: _____

To,

M/s. _____ (Name and address of the contractor)

Subject: Construction cover shed of Washing bay Platform at ISDSM Indore District - Indore (M.P.)

Dear Sir(s),

Your bid for the work mentioned above has been accepted on behalf of the Governor of Madhya Pradesh at your bided percentage _____ below/ above or at par the Bill of Quantities and item wise rates given therein.

You are requested to submit within 15 (Fifteen) days from the date of issue of this letter:

- a. The performance security/ performance guarantee of Rs. _____ (in figures) (Rupees _____ in words only). The performance security shall be in the shape of term deposit receipt/ bank guarantee of any nationalized / schedule commercial bank valid up to three months after the expiry of defects liability period.
- b. Sign the contract agreement.

Please note that the time allowed for carrying out the work as entered in the bid is _____ months including rainy season, shall be reckoned from the date of signing the contract agreement.

Signing the contract agreement shall be reckoned as intimation to commencement of work and no separate letter for commencement of work is required. Therefore, after signing of the agreement, you are directed to contact the Engineer-in-charge for taking the possession of site and necessary instructions to start the work.

Yours Faithfully

**Chief Executive Officer
Indore dugdha sangh Indore**

PERFORMANCE SECURITY

To,

_____ [name of Employer]

_____ [name of Employer]

WHEREAS _____ [name and address of Contractor] (Hereinafter called "the Contractor") has undertaken, in pursuance of Letter of Acceptance No. _____ dated _____ to execute _____ [name of Contract and brief description of Works] (hereinafter called "the Contract").

AND WHEREAS it has been stipulated by you in the said Contract that the Contractor shall furnish you with a Bank Guarantee by a recognized bank for the sum specified therein as security for compliance with his obligation in accordance with the Contract;

AND WHEREAS we have agreed to give the Contractor such a Bank Guarantee:

NOW THEREFORE we hereby affirm that we are the Guarantor and responsible to you on behalf of the Contractor, up to a total of _____ [amount of guarantee]* _____ (in words), such sum being payable in the types and proportions of currencies in which the Contract Price is payable, and we undertake to pay you, upon your first written demand and without cavil or argument, any sum or sums within the limits of _____ [amount of guarantee] as aforesaid without your needing to prove or to show grounds or reasons for your demand for the sum specified therein.

We hereby waive the necessity of your demanding the said debt from the contractor before presenting us with the demand.

We further agree that no change or addition to or other modification of the terms of the Contract of the Works to be performed there under or of any of the Contract documents which may be made between you and the Contractor shall in any way release us from any liability under this guarantee, and we hereby waive notice of any such change, addition or modification.

This guarantee shall be valid until 3 (three) months from the date of expiry of the Defect Liability Period.

Signature, Name and Seal of the guarantor _____

Name of Bank _____

Address _____

Phone No., Fax No., E-mail Address, of Signing Authority _____

Date _____

* An amount shall be inserted by the Guarantor, representing the percentage the Contract Price specified in the Contract including additional security for unbalanced Bids, if any and denominated _____ in _____ Indian Rupees.

SECTION 3
Conditions of Contract
Part – I General Conditions of Contract [GCC]

Table of Clauses of GCC

Clause No	Particulars	Clause No	Particulars
	A. General	21	Payments for Variations and / or Extra Quantities
1	Definitions	22	No compensation for alterations in or restriction of work to be carried out.
2	Interpretations and Documents	23	No Interest Payable
3	Language and Law	24	Recovery from Contractors
4	Communications	25	Tax
5	Subcontracting	26	Check Measurements
6	Personnel	27	Termination by Engineer in Charge
7	Force Majeure	28	Payment upon Termination
8	Contractor's Risks	29	Performance Security
9	Liability For Accidents To Person	30	Security Deposit
10	Contractor to Construct the Works	31	Price Adjustment
11	Discoveries	32	Mobilization and Construction Machinery Advance
12	Dispute Resolution System	33	Secured Advance
	B. Time Control	34	Payments Certificates
13	Programme		E. Finishing the Contract
14	Extension of Time	35	Completion Certificate
15	Compensation for Delay	36	Final Account
16	Contractor's quoted percentage		F. Other Conditions of Contract
	C. Quality Control	37	Currencies
17	Tests	38	Labour
18	Correction of Defects noticed during the Defect Liability Period	39	Compliance with Labour Regulations
	D. Cost Control	40	Audit and Technical Examination
19	Variations - Change in original Specifications, Designs, Drawings etc.	41	Death or Permanent Invalidity of Contractor
20	Extra Items	42	Jurisdiction

A. General

1. DEFINITIONS

- 1.1. **Bill of Quantities:** means the priced and completed Bill of Quantities forming part of the Bid.
- 1.2. **Engineer in Chief / Chief Engineer:** means Engineer in Chief / Chief Engineer of the Directorate of Urban Administration & Development.
- 1.3. **Completion:** means completion of the work as certified by the Engineer-in-Charge, in accordance with provisions of agreement.
- 1.4. **Contract:** means the Contract between the Employer and the Contractor to execute, complete and/or maintain the work. Agreement is synonym of Contract and carries the same meaning wherever used.
- 1.5. **Contract Data:** means the documents and other information which comprise of the Contract.
- 1.6. **Contractor:** means a person or legal entity whose bid to carry out the work has been accepted by the Employer.
- 1.7. **Contractor's bid:** means the completed bid document submitted by the Contractor to the Employer.
- 1.8. **Contract amount:** means the amount of contract worked out on the basis of accepted bid.
- 1.9. **Completion of work:** means completion of the entire contracted work. Exhaustion of quantity of any particular item mentioned in the bid document shall not imply completion of work or any component thereof.
- 1.10. **Day:** means the calendar day.
- 1.11. **Defect:** means any part of the work not completed in accordance with the specifications included in the contract.
- 1.12. **Department:** means Department of the State Government viz. Urban Development & Environment Department.
- 1.13. **Drawings:** means drawings including calculations and other information provided or approved by the Engineer-in-Charge.
- 1.14. **Employer:** means the party as defined in the **Contract Data**, who employs the Contractor to carry out the work. The Employer may delegate any or all functions to a person or body nominated by him for specified functions. The word Employer / Government / Department wherever used denote the Employer.
- 1.15. **Engineer:** means the Engineer designated by the Chief Executive Officer, Indore dugdha sangh indore(M.P.)
- 1.16. **Engineer in charge:** means the Executive Engineer of the department or the person designated by the Indore dugdha sangh indore(M.P.).
- 1.17. **Equipment:** means the Contractor's machinery and vehicles brought temporarily to the Site for execution of work.
- 1.18. **Government:** means Government of Madhya Pradesh.
- 1.19. **In Writing:** means communicated in written form and delivered against receipt.
- 1.20. **Material:** means all supplies, including consumables, used by the Contractor for in council in the work.
- 1.21. Deleted
- 1.22. **Project** means: Construction of Washing bay platform District - Indore
- 1.23. Deleted
- 1.24. **Stipulated period of completion:** means the period in which the Contractor is required to complete the work. The stipulated period is specified in the **Contract Data**.
- 1.25. **Specification:** means the specification of the work included in the Contract and any

modification or addition made or approved by the Engineer-in-Charge.

- 1.26. **Start Date:** means the date of signing of agreement for the work.
- 1.27. **Sub-Contractor:** means a person or corporate body who has a Contract with the Contractor, duly authorized and approved by the employer to carry out a part of the construction work under the Contract.
- 1.28. **Temporary Work:** means work designed, constructed, installed, and removed by the Contractor that are needed for construction or installation of the work.
- 1.29. **Tender/Bid, Tenderer/Bidder:** are the synonyms and carry the same meaning where ever used.
- 1.30. **Variation:** means any change in the work which is instructed or approved as variation under this contract.
- 1.31. **Work:** The expression "work" or "works" where used in these conditions shall unless there be something either in the subject or context repugnant to such construction, be construed and taken to mean the work by virtue of contract, contracted to be executed, whether temporary or permanent and whether original, altered, substituted or additional.

2. INTERPRETATIONS AND DOCUMENTS

2.1 Interpretations

In the contract, except where the context requires otherwise:

- a. words indicating one gender include all genders;
- b. words indicating the singular also include the plural and vice versa.
- c. provisions including the word "agree", "agreed" or "agreement" require the agreement to be recorded in writing;
- d. "written" or "in writing" means hand-written, type-written, printed or electronically made, and resulting in a permanent record;

2.2 Documents Forming Part of Contract:

1. NIT with all amendments.
2. Instructions to Bidders (ITB, Bid Data Sheet with all Annexures)
3. Conditions of Contract:
 - i. Part-I General Conditions of Contract and the Contract Data; with all Annexures
 - ii. Part-II Special Conditions of Contract.
4. Specifications
5. Drawings
6. Bill of Quantities
7. Technical and Financial Bid
8. Agreement, and
9. Any other document(s), as specified.

3. Language and Law

The language of the Contract and the law governing the Contract are stated in the Contract Data.

4. Communications

All certificates, notice or instruction to be given to the Contractor by Employer/ Engineer shall be sent to the address or contact details given by the Contractor in [Annexure-H of ITB]. The address and contact details for communication with the Employer/Engineer shall be as per the details given in the Contract Data. Communication between parties that are referred to in the conditions shall be in writing. The notice sent by facsimile (fax) or other electronic means (email) shall also be effective on confirmation of the transmission. The notice sent by registered post or speed post shall be effective on delivery or at the expiry of the normal delivery period as undertaken by the postal

service. In case of any change in address for communication, the same shall be immediately notified to Engineer-in-Charge.

5. Subcontracting

Subcontracting shall be permitted for contracts of value more than amount specified in the Contract Data with following conditions.

- a. The Contractor may subcontract up to 25 percent of the contract price with the approval of the Employer in writing, but will not assign the Contract. Subcontracting shall not alter the Contractor's obligations.
- b. Following shall not form part of subcontracting:
 - i. Hiring of labour through a labour contractor.
 - ii. The purchase of Materials to be incorporated in the works.
 - iii. Hiring of plant & machinery
- c. The sub-contractor will have to be registered in the **appropriate category** in the centralized registration system for contractors of the Go MP.

6. Personnel

- 6.1** The Contractor shall employ for the construction work and routine maintenance the technical personnel as provided in the Annexure I-3 of Bid Data Sheet, if applicable. If the Contractor fails to deploy required number of technical staff, recovery as specified in the Contract Data will be made from the Contractor.
- 6.2** If the Engineer asks the Contractor to remove a person who is a member of the Contractor's staff or work force, stating the reasons, the Contractor shall ensure that the person leaves the Site within three days and has no further connection with the Works in the Contract.

7. Force Majeure

7.1 The term "Force Majeure" means an exceptional event or circumstance:

- (a) Which is beyond a Party's control,
- (b) Which such Party could not reasonably have provided against before entering into the Contract,
- (c) Which, having arisen, such Party could not reasonably have avoided or overcome, and
- (d) Which is not substantially attributable to the other Party.

Force Majeure may include, but is not limited to, exceptional events or circumstances of the kind listed below, so long as conditions (a) to (d) above are satisfied:

- (i) War, hostilities (whether war be declared or not), invasion, act of foreign enemies,
- (ii) Rebellion, terrorism, sabotage by persons other than the Contractor's Personnel, revolution, insurrection, military or usurped power, or civil war,
- (iii) Riot, commotion, disorder, strike or lockout by persons other than the Contractor's Personnel,
- (iv) Munitions of war, explosive materials, ionizing radiation or contamination by radio-activity, except as may be attributable to the Contractor's use of such munitions, explosives, radiation or radio-activity, and
- (v) Natural catastrophes such as earthquake, hurricane, typhoon or volcanic activity.

7.2. In the event of either party being rendered unable by force majeure to perform any duty

or discharge any responsibility arising out of the contract, the relative obligation of the party affected by such force majeure shall upon notification to the other party be suspended for the period during which force majeure event lasts. The cost and loss sustained by either party shall be borne by respective parties.

7.3 For the period of extension granted to the Contractor due to Force Majeure the price adjustment clause shall apply but the penalty clause shall not apply. It is clarified that this sub clause shall not give eligibility for price adjustment to contracts which are otherwise not subject to the benefit of price adjustment clause.

7.4 The time for performance of the relative obligation suspended by the force majeure shall stand extended by the period for which such cause lasts. Should the delay caused by force majeure exceed **twelve** months, the parties to the contract shall be at liberty to foreclose the contract after holding mutual discussions.

8. Contractor's Risks

8.1 All risks of loss or damage to physical property and of personal injury and death which arise during and in consequence of the performance of the Contract are the responsibility of the Contractor.

8.2 All risks and consequences arising from the inaccuracies or falseness of the documents, drawing, designs, other documents and/or information submitted by the contractor shall be the responsibility of the Contractor alone, notwithstanding the fact that the designs/ drawings or other documents have been approved by the department.

9. Liability for Accidents to Person

The contractor shall be deemed to have indemnified and saved harmless the Government against all action, suits, claims, demands, costs etc. arising in connection with injuries suffered by any persons employed by the contractor or his subcontractor for the works whether under the General law or under Workman's Compensation Act, or any other statute in force at the time of dealing with the question of the liability of employees for the injuries suffered by employees and to have taken steps properly to ensure against any claim there under.

10. Contractor to Construct the Works

10.1 The Contractor shall construct, install and maintain the Works in accordance with the Specifications and Drawings as specified in the **Contract Data**.

10.2 In the case of any class of work for which there is no such specification as is mentioned in Contract Data, such work shall be carried out in accordance with the instructions and requirement of the Engineer-in-charge.

10.3 The contractor shall supply and take upon himself the entire responsibility of the sufficiency of the scaffolding, timbering, machinery, tools and implements, and generally of all means used for the fulfillment of this contract whether such means may or may not be approved or recommended by the Engineer.

11. Discoveries

Anything of historical or other interest or of significant value unexpectedly discovered on the Site shall be the property of the Employer. The Contractor shall notify the Engineer of such discoveries and carry out the Engineer's instructions for dealing with them.

12. Dispute Resolution System

- 12.1 No dispute can be raised except before the Competent Authority as defined in Contract Data in writing giving full description and grounds of dispute. It is clarified that merely recording protest while accepting measurement and/or payment shall not be taken as raising a dispute.
- 12.2 No dispute can be raised after 45 days of its first occurrence. Any dispute raised after expiry of 45 days of its first occurrence shall not be entertained and the Employer shall not be liable for claims arising out of such dispute.
- 12.3 The **Competent Authority** shall decide the matter within 45 days.
- 12.4 Appeal against the order of the Competent Authority can be preferred within 30 days to the **Appellate Authority** as defined in **the Contract Data**. The Appellate Authority shall decide the dispute within 45 days.
- 12.5 Appeal against the order of the Appellate Authority can be preferred before the Madhya Pradesh Arbitration Tribunal constituted under Madhya Pradesh *Madhyastham Adhikaran Adhiniyam*, 1983.
- 12.6 The Contractor shall have to continue execution of the Works with due diligence notwithstanding pendency of a dispute before any authority or forum.

B. Time Control

13. Programme

- 13.1 Within the time stated in the Contract Data, the Contractor shall submit to the Engineer for approval a Programme showing the general methods, arrangements, order and timing for all the activities for the construction of works.
- 13.2 **The program shall be supported with all the details regarding key personnel, equipment and machinery proposed to be deployed on the works for its execution.** The contractor shall submit the list of equipment and machinery being brought to site, the list of key personnel being deployed, the list of machinery/equipment being placed in field laboratory and the location of field laboratory along with the Programme.
- 13.3 An update of the Programme shall be a programme showing the actual progress achieved on each activity and the effect of the progress achieved on the timing of the remaining Works, including any changes to the sequence of the activities.
- 13.4 The Contractor shall submit to the Engineer for approval an updated Programme at intervals no longer than the period stated in the **Contract Data**. If the Contractor does not submit an updated Programme within this period, the Engineer may withhold the amount stated in the **Contract Data** from the next payment certificate and continue to withhold this amount until the next payment after the date on which the overdue Programme has been submitted.
- 13.5 The Engineer's approval of the Programme shall not alter the Contractor's obligations.

14. Extension of Time

- 14.1. If the Contractor desires an extension of time for completion of the work on the ground of his having been unavoidably hindered in its execution or on any other grounds, he shall apply, in writing, to the Engineer-in-charge, on account of

which he desires such extension. **Engineer-in-Charge shall forward the aforesaid application to the Competent Authority as prescribed.**

- 14.2 The competent authority shall grant such extension at each such occasion within a period of 30 days of receipt of application from contractor and shall not wait for finality of work. Such extensions shall be granted in accordance with provisions under **clause- 15** of this agreement.
- 14.3 In case the work is already in progress, the Contractor shall proceed with the execution of the works, including maintenance thereof, pending receipt of the decision of the competent authority as aforesaid with all due diligence.

15. Compensation for delay

- 15.1 The time allowed for carrying out the work, as entered in the agreement, shall be strictly observed by the Contractor.
- 15.2 The time allowed for execution of the contract shall commence from the date of signing of the agreement. It is clarified that the need for issue of work order is dispensed with.
- 15.3 In the event milestones are laid down in the Contract Data for execution of the works, the contractor shall have to ensure strict adherence to the same.
- 15.4 Failure of the Contractor to adhere to the timelines and/or milestones shall attract such liquidated damages as is laid down in the Contract Data.
- 15.5 In the event of delay in execution of the Works as per the timelines mentioned in the Contract Data the Engineer-in-charge shall retain from the bills of the Contractor amount equal to the liquidated damages leviable until the Contractor makes such delays good. However, the Engineer-in-charge shall accept bankable security in lieu of retaining such amount.
- 15.6 If the Contractor is given extension of time after liquidated damages have been paid, the Engineer-in-Charge shall correct any over payment of liquidated damages by the Contractor in the next payment certificate.
- 15.7 In the event the Contractor fails to make good the delay until completion of the stipulated contract period (including extension of time) the sum so retained shall be adjusted against the liquidated damages levied.

16. Contractor's quoted percentage

The Contractor's quoted percentage rate referred to in the "Bid for works" will be deducted/ added from/to the net amount of the bill after deducting the cost of material supplied by the department.

C. Quality Control

17. Tests

- 17.1 The Contractor shall be responsible for:
 - a. Carrying out the tests prescribed in specifications, and
 - b. For the correctness of the test results, whether preformed in his laboratory or elsewhere.
- 17.2 The contractor shall have to establish field laboratory within the time specified and having such equipments as are specified in the **Contract Data**.

17.3 Failure of the Contractor to establish laboratory shall attract such penalty as is specified in the **Contract Data**.

18. Correction of Defects noticed during the Defect Liability Period

18.1 The Defect Liability Period of work in the contract shall be as per the **Contract Data**.

18.2 The Contractor shall promptly rectify all defects pointed out by the Engineer well before the end of the Defect Liability Period. The Defect Liability Period shall automatically stand extended until the defect is rectified.

18.3 If the Contractor has not corrected a Defect pertaining to the Defect Liability Period to the satisfaction of the Engineer, within the time specified by the Engineer, the Engineer will assess the cost of having the Defect corrected, and the cost of correction of the Defect shall be recovered from the Performance Security or any amount due or that may become due to the contractor and other available securities.

D. Cost Control

19. Variations - Change in original Specifications, Designs, and Drawings etc.

19.1 The Engineer-in-charge shall have power to make any alterations, omissions or additions to or substitutions in the original specifications, drawings, designs and instructions, that may appear to him to be necessary during the progress of the work and the contractor shall carry out the work in accordance with any instructions which may be given to him in writing signed by the Engineer-in-charge, and such alterations, omission, additions or substitutions shall not invalidate the contract and any altered, additional or substituted work, which the contractor may be directed to do in the manner above specified, as part of the work, shall be carried out by the contractor on the same conditions in all respects on which he agrees to do the main work.

19.2 The time for the completion of the work shall be adjusted in the proportion that the altered, additional or substituted work bears to the original contract work and the certificate of the Engineer-in-charge shall be conclusive as to such proportion.

20. Extra items

20.1 All such items which are not included in the priced BOQ shall be treated as extra items.

21. Payments for Variations and / or Extra Quantities

21.1 The rates for such additional (Extra quantity), altered or substituted work / extra items under this clause shall be worked out in accordance with the following provisions in their respective order:-

- a. The contractor is bound to carry out the additional (Extra quantity), work at **the same rates** as are specified in the contract for the work.
- b. If the item is not in the priced BOQ and is included in the SOR of the department, the rate shall be arrived at by applying the quoted tender percentage on the SOR rate.

- c. **If the rates for the altered or substituted work are not provided in applicable SOR** – such rates will be derived from the rates for a similar class (type) of work as is provided in the contract (priced BOQ) for the work.
- d. **If the rates for the altered, substituted work cannot be determined in the manner specified in the sub clause (c) above** - then the rates for such composite work item shall be worked out on the basis of the concerned Schedule of Rates minus/plus the percentage quoted by the contractor.
- e. If the rates for a particular part or parts of the item is not in the Schedule of Rates and the rates for the altered, or substituted work item cannot be determined in the manner specified in sub clause (b) to (d) above, the rate for such part or parts will be determined by the Competent Authority as defined in the Contract Data on the basis of the rate analysis derived out of prevailing market rates when the work was done.
- f. But under no circumstances, the contractor shall suspend the work on the plea of non-acceptability of rates on items falling under sub clause (a) to (d). In case the contractor does not accept the rate approved by the Engineer in Charge for a particular item, the contractor shall continue to carry out the item at the rates determined by the Competent Authority. The decision on the final rates payable shall be arrived at through the dispute settlement procedure.

22. No compensation for alterations in or restriction of work to be carried out.

- 22.1** If at any time after the commencement of the work, the Engineer-in-charge, for any reason whatsoever, not require the whole or any part of the work as specified in the bid to be carried out; the Engineer-in-charge shall give notice in writing of the fact to the Contractor and withdraw that whole or any part of the work.
- 22.2** The Contractor shall have no claim to any payments or compensation whatsoever, on account of any profit or advantage which he might have derived from the execution of work in full or on account of any loss incurred for idle men and machinery due to any alteration or restriction of work for whatsoever reason.
- 22.3** The Engineer-in-charge may supplement the work by engaging another agency to execute such portion of the work, without prejudice to his rights.

23. No Interest Payable

No interest shall be payable to the Contractor on any payment due or awarded by any authority.

24. Recovery from Contractors

Whenever any claim against the Contractor for the payment arises under the contract, the Department may be entitled to recover such sum by:

- (a)** Appropriating, in part or whole of the Performance Security and Additional Performance Security, if any; and/or Security Deposit and / or any sums payable under the contract to the contractor.
- (b)** If the amount recovered in accordance with (a) above is not sufficient, the balance sum may be recovered from any payment due to the contractor under any other contract of the department, including the securities which become due for release.

- (c) The department shall, further have an additional right to effect recoveries as arrears of land revenue under the *M.P. Land Revenue Code*.

25. Tax

- 25.1** The rates quoted by the Contractor shall be deemed to be inclusive of the commercial tax and other levies, duties, cess, toll, taxes of Central and State Governments, local bodies and authorities.
- 25.2** The liability, if any, on account of quarry fees, royalties, octroi and any other taxes and duties in respect of materials actually consumed on public work, shall be borne by the Contractor.
- 25.3** Any changes in the taxes due to change in legislation or for any other reason shall not be payable to the contractor.

26. Check Measurements

- 26.1** The department reserves to itself the right to prescribe a scale of check measurement of work in general or specific scale for specific works or by other special orders.
- 26.2** Checking of measurement by superior officer shall supersede measurements by subordinate officer(s), and the former will become the basis of the payment.
- 26.3** Any over/ excess payments detected, as a result of such check measurement or otherwise at any stage up to the date of completion of the defect liability period specified in this contract, shall be recoverable from the Contractor, as per **clause 24** above.

27. Termination by Engineer in Charge

- 27.1** If the Contractor fails to carry out any obligation under the Contract, the Engineer-in-Charge may by notice require the Contractor to make good the failure and to remedy it within a specified reasonable time.
- 27.2** The Engineer in Charge shall be entitled to terminate the Contract if the Contractor
- a)** abandons the Works or otherwise plainly demonstrates the intention not to continue performance of his obligations under the Contract;
 - b)** the Contractor is declared as bankrupt or goes into liquidation other than for approved reconstruction or amalgamation;
 - c)** without reasonable excuse fails to comply with the notice to correct a particular defect within a reasonable period of time;
 - d)** the Contractor does not maintain a valid instrument of financial security as prescribed;
 - e)** the Contractor has delayed the completion of the Works by such duration for which the maximum amount of liquidated damages is recoverable;
 - f)** If the Contractor fails to deploy machinery and equipment or personnel or set up a field laboratory as specified in the **Contract Data**;
 - g)** If the contractor, in the judgment of the Engineer in charge has engaged in corrupt or fraudulent practices in competing for or in executing the contract;
 - h)** Any other fundamental breaches as specified in the **Contract Data**.
- 27.3** In any of these events or circumstances, the Engineer in Charge may, upon giving 14 days' notice to the Contractor, terminate the Contract and expel the Contractor

from the Site. However, in the case of sub-paragraph (b) or (g) of **clause 27.2**, the Engineer-in-Charge may terminate the Contract immediately.

- 27.4** Notwithstanding the above, the Engineer-in-Charge may terminate the Contract for convenience by giving notice to the Contractor.

28. Payment upon Termination

28.1 If the contract is terminated under **clause 27.3**, the Engineer shall issue a certificate for value of the work accepted on final measurements, less Advance Payments and Penalty as indicated in the **Contract Data**. The amount so arrived at shall be determined by the **Engineer-in-Charge** and shall be final and binding on both the parties.

28.2 Payment on termination under **clause 27.4** above -
If the Contract is terminated under **clause 27.4** above, the Engineer shall issue a certificate for the value of the work done, the reasonable cost of removal of Equipment, repatriation of the Contractor's personnel employed solely on the Works, and the Contractor's costs of protecting and securing the Works and less advance payments received up to the date of the certificate, less other recoveries due in terms of the contract and less taxes due to be deducted at source as per applicable law.

28.3 If the total amount due to the Employer exceeds any payment due to the Contractor, the difference shall be recovered as per **clause 24** above.

29. Performance Security

The Contractor shall have to submit performance security and additional performance security, if any, as specified in the **Bid Data Sheet** at the time of signing of the contract. The contractor shall have to ensure that such performance security and additional performance security, if any, remains valid for the period as specified in the Contract Data.

30. Security Deposit-

30.1 Security Deposit shall be deducted from each running bill at the rate as specified in the **Contract Data**. The total amount of Security Deposit so deducted shall not exceed the percentage of Contract Price specified in the **Contract Data**.

30.2 The security deposit may be replaced by equivalent amount of bank guarantee or fixed deposit receipt assigned to the Employer, with validity up to 3 (three) months beyond the completion of Defect Liability Period/ extended Defect Liability Period.

30.3 The Security Deposit shall be refunded on completion of Defect Liability Period.

31. Price Adjustment - Deleted

32. Mobilization Advance

32.1 Payment of advances shall be applicable if provided in the **Contract Data**.

32.2 If applicable, the Engineer in Charge shall make interest bearing advance payment to the contractor of the amounts stated in the **Contract Data**, against

provision by the contractor of an unconditional Bank Guarantee in a form and by a nationalized/ scheduled banks, in the name as stated in the **Contract Data**, in amounts equal to the advance payment. The guarantee shall remain effective until the advance payment has been repaid, but the amount of the guarantee shall be progressively reduced by the amounts repaid by the contractor.

32.3 The rate of interest chargeable shall be as per **Contract Data**.

32.4 Deleted

32.5 The advance payment shall be recovered as stated in the **Contract Data** by deducting proportionate amounts from payment otherwise due to the Contractor. No account shall be taken of the advance payment or its recovery in assessing valuations of work done, variations, price adjustments, compensation events, or liquidated damages.

33. Secured Advance - Deleted

34. Payment Certificates

The payment to the contractor will be as follows for construction work:

- (a) The Contractor shall submit to the Engineer monthly statements of the value of the work executed less the cumulative amount certified previously, supported with detailed measurement of the items of work executed.
- (b) The Engineer shall check the Contractor's monthly statement and certify the amount to be paid to the Contractor.
- (c) The value of work executed shall be determined, based on the measurements approved by the Engineer/ Engineer-in-charge.
- (d) The value of work executed shall comprise the value of the quantities of the items in the Bill of Quantities completed.
- (e) The value of work executed shall also include the valuation of Variations and Compensation Events.
- (f) All payments shall be adjusted for deductions for advance payment, security deposit, other recoveries in terms of contract and taxes at source as applicable under the law.
- (g) The Engineer may exclude any item certified in a previous certificate or reduce the proportion of any item previously certified in any certificate in the light of later information.
- (h) Payment of intermediate certificate shall be regarded as payments by way of advance against the final payment and not as payments for work actually done and completed.
- (i) Intermediate payment shall not preclude the requiring of bad, unsound and imperfect or unskilled work to be removed and taken away and reconstructed or be considered as an admission of the due performance of the contractor any part thereof, in any respect or the occurring of any claim.
- (j) The payment of final bill shall be governed by the provisions of **clause 36 of GCC**.

E. Finishing the Contract

35. Completion Certificate

- 35.1** A Completion Certificate in the prescribed format in **Contract Data** shall be issued by the Engineer-in-Charge after physical completion of the Work.
- 35.2** After final payment to the Contractor, a Final Completion Certificate in the prescribed format in the **Contract Data** shall be issued by the Engineer-in-Charge.

36. Final Account

- 36.1** The Contractor shall supply the Engineer with a detailed account of the total amount that the Contractor considers payable for works under the Contract within 21 days of issue of certificate of physical completion of works. The Engineer shall issue a Defects Liability Certificate and certify any payment that is due to the Contractor within 45 days of receiving the Contractor's account if it is correct and complete. If the account is not correct or complete, the Engineer shall issue within 45 days a schedule that states the scope of the corrections or additions that are necessary. If the Account is still unsatisfactory after it has been resubmitted, the matter shall be referred to the Competent Authority as defined in the Contract Data, who shall decide on the amount payable to the Contractor after hearing the Contractor and the Engineer in Charge.
- 36.2** In case the account is not received within 21 days of issue of Certificate of Completion as provided in clause 32.1 above, the Engineer shall proceed to finalize the account and issue a payment certificate within 28 days.

F. Other Conditions of Contract

37. Currencies

All payments will be made in Indian Rupees.

38. Labour

- 38.1** The Contractor shall, unless otherwise provided in the Contract, make his own arrangements for the engagement of all staff and labour, local or other, and for their payment, housing, feeding and transport.
- 38.2** The Contractor shall, if required by the Engineer, deliver to the Engineer a return in detail, in such form and at such intervals as the Engineer may prescribe, showing the staff and the numbers of the several classes of labour from time to time employed by the Contractor on the Site and such other information as the Engineer may require.

39. Compliance with Labour Regulations

- 39.1.** During continuance of the Contract, the Contractor and his sub-Contractors shall abide at all times by all existing labour enactments and rules made there under, regulations, notifications and bye laws of the State or Central Government or local authority and any other labour law (including rules), regulations, bye laws that may be passed or notification that may be issued under any labour law in future either by the State or the Central Government or the local authority. Salient features of some of the major labour laws that are applicable to construction industry are given in the **Contract Data**. The Contractor shall keep the

Employer indemnified in case any action is taken against the Employer by the competent authority on account of contravention of any of the provisions of any Act or rules made their under, regulations or notifications including amendments. If the Employer is caused to pay or reimburse, such amounts as may be necessary to cause or observe, or for non-observance of the provisions stipulated in the notifications/ byelaws/ Acts/ Rules/ regulations including amendments, if any, on the part of the Contractor, the Engineer/Employer shall have the right to deduct from any money due to the Contractor including his amount of performance security. The Employer/Engineer shall also have right to recover from the Contractor any sum required or estimated to be required for making good the loss or damage suffered by the Employer. The employees of the Contractor and the Sub-Contractor in no case shall be treated as the employees of the Employer at any point of time.

40. Audit and Technical Examination

Government shall have the right to cause an audit and technical examination of the works and the final bill of the contract including all supporting vouchers, abstract etc. to be made after payment of the final bill and if as a result of such audit and technical examination any sum is found to have been overpaid in respect of any work done by the contractor under the contract or any work claimed by him to have been done under the contract and found not to, have been executed, the Contractor shall be liable to refund the amount of overpayment and it shall be lawful for Government to recover the same from him in the manner prescribed in **clause 24** above and if it is found that the Contractor was paid less than what was due to him, under the contract in respect of any work executed by him under it, the amount of such under payment shall be duly paid by Government to the Contractor.

41. Death or Permanent Invalidity of Contractor

If the Contractor is an individual or a proprietary concern, partnership concern, dies during the currency of the contract or becomes permanently incapacitated, where the surviving partners are only minors, the contract shall be closed without levying any damages/ compensation as provided for in **clause 28.2** of the contract agreement. However, if the competent authority is satisfied about the competence of the survivors, then the competent authority shall enter into a fresh agreement for the remaining work strictly on the same terms and conditions under which the contract was awarded.

42. Jurisdiction

This contract has been entered into the State of Madhya Pradesh and its validity, construction, interpretation and legal effect shall be subjected to the courts at the place where this agreement is entered into. No other jurisdiction shall be applicable.

[End of GCC]

Contract Data

Clause Ref.	Particulars	Data
1.14	Employer	Indore sahakari dugdh sangh maryadit indore
1.15	Engineer	Person as designated by the Chief Executive Officer Indore sahakari dugdh sangh maryadit indore
1.22	Stipulated period of completion	1 Months
3	Language & Law of Contract	English & Indian Contract Act, 1872
4	Address & contact details of the Contractor	As per Annexure H
	Address & contact details of the Employer/ Engineer - phone, Fax, e-mail	Indore sahakari dugdh sangh maryadit indore
5	Subcontracting permitted for the Contract Value	not more than 25 % of tender amount
6	Technical Personnel to be provided by the contractor – requirement	As per Annexure I (Format I-3)
	Penalty, if required Technical Personnel not employed	Rs. 20,000/- per month per Technical Personnel For 1-3 in As per Annexure-I (Format: I – 3) Rs. 15,000/- per month per Technical Personnel For 4-6 in As per Annexure-I (Format: I – 3)
10	Specifications	As per Annexure E
	Drawings	As per Annexure - N
12	Competent Authority for deciding dispute under Dispute Resolution System	Person Authorized by chief Executive Officer Indore sahakari dugdh sangh maryadit indore
	Appellate Authority for deciding dispute under Dispute Resolution System	Chief Executive Officer ,Indore dugdha sangh indore ,
13	Period of submission of work programme	15 days from the date of signing the agreement
	Period for submission of updated construction program	One months
	Amount to be withheld for not submitting construction program in prescribed period	Rs. 10,000/- per event
14	Competent Authority for granting Time Extension	Chief Excutive Officer ,Indore dugdha sangh indore
15	Milestones laid down for the contract	Yes <input type="checkbox"/> No <input checked="" type="checkbox"/>
	If Yes, details of Milestones	As per Annexure - O
	Liquidated damage	As per Annexure - P
17	List of equipment for lab	As per Annexure - Q
	Time to establish lab	Before execution of work at site
	Penalty for not establishing field Laboratory	Rs. 10,000/- per month for the delay
18	Defect Liability Period	12 Months after issue of final completion certificate
21	Competent Authority for determining the rate	Chief Excutive Officer ,Indore dugdha sangh indore
27	Any other condition for breach of contract	

Contract Data

Clause reference	Particulars	Data
28	Penalty	Penalty Shall include (a) Security Deposit as per clause 30 of General Conditions of Contract, and (b) Liquidated Damages imposed as per clause 15 or Performance Security (Guarantee) including Additional Performance Security (Guarantee), if any, as per clause 29 of General Conditions of Contract, whichever is higher
29	Performance guarantee (Security) shall be valid up to	Till issue of final Completion Certificate as per Clause 35.1
30	Security Deposit to be deducted from each running bill	At the rate of 5%.
	Maximum limit of deduction of Security Deposit	Up to 5% of Final Contract Amount.
31	Price Adjustment formula and procedure to calculate	Deleted
31.1 (1)	Price adjustment shall be applicable	Deleted
32	32.1 Mobilization Advance Applicable	Yes
	32.2 If yes, Unconditional Bank Guarantee of 110 % of Mobilization Advance	In the format prescribed in Annexure - S
	32.3 If yes, Rate of interest chargeable on advances	Interest rate (computed quarterly) as per notified bank rate on the date of inviting tender
	32.4 If yes, Type & Amount of Advance payment that can be paid	1. Mobilization advance-Not more than 10% of contract amount
	32.5 If yes, Recovery of advance payment	Recovery of Mobilization advance shall commence when 10% of the contract amount is executed and recovery of total advance shall be done on pro-rata basis and shall be completed by the time work equivalent to 80% of the contract amount is executed. In addition to the recovery of principal amount, recovery of interest shall be carried out as calculated on the outstanding amount of principal at the close of each month. The interest shall be accrue from the day of payment of advance and the recovery of interest shall commence when 10% of the contract amount is executed and shall be completed by the time work equivalent to 80% of the contract amount is executed.

Contract Data

Clause reference	Particulars	Data
33	33.1 Secured Advance Applicable	No Secured Advance payable.
	33.2 if yes, Unconditional Bank Guarantee	Not Applicable
	33.2 if yes, Amount of Secured Advance	Not Applicable
	33.3 if yes, Conditions for secured advance	Not Applicable
	33.4 if yes, Recovery of Secured advance	Not Applicable
35	Completion Certificate – after physical completion of the Work	As per Annexure - U
	Final Completion Certificate – after final payment on completion of the Work	As per Annexure- V
36	Competent Authority	Chief Excutive Officer ,Indore dugdha sangh indore
37	Salient features of some of the major labour laws that are applicable	As per Annexure-W

Drawings of washing bay platform

List of drawings -

1. Site Plan.
2. Layout Plan
3. Floor Plans
4. Section
5. Elevation

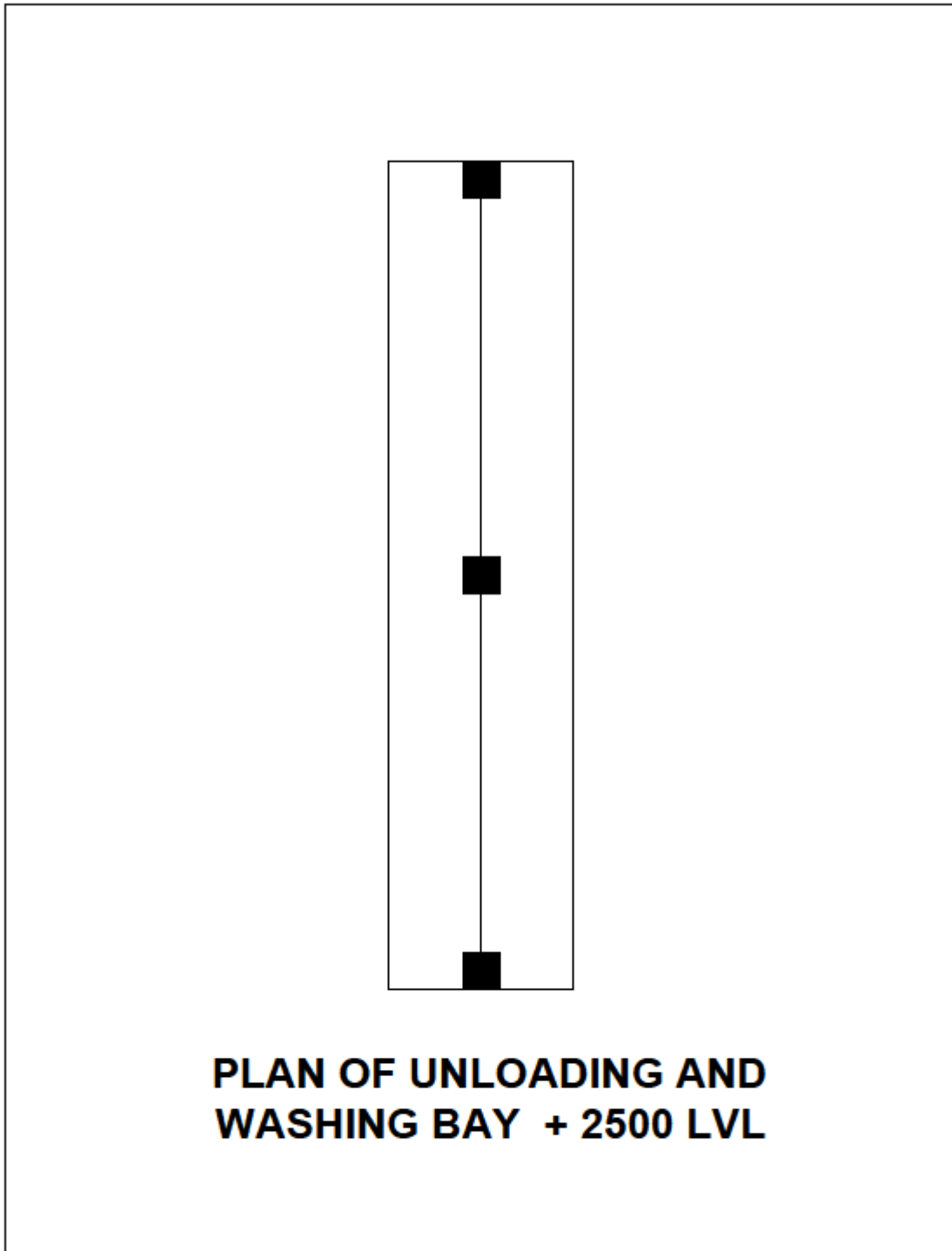

PLAN OF UNLOADING AND WASHING BAY + 2500 LVL

PROJECT: PROPOSED PROJECT OF UNLOADING AND WASHING BAAT DUGH		TITLE: PLAN OF UNLOADING AND WASHING BAY		CLIENT:-	
DARY CAMPUS UNDER INDORE SAHKARI DUGH SANGH MARYADIT INDORE(M.P)		DATE: 1/02/2011	DWG.BY:		CONSULTANTS/ARCHITECT MARIGO CONSULTANTS <small>INDORE/ARCHITECTS/PROJECT CONSULTANTS</small> <small>304/INDORE APARTMENT ANANDNAGAR</small> <small>A.S. ROAD INDORE (M.P)</small>
INDORE SAHKARI DUGH SANGH MARYADIT INDORE(M.P)					
CLIENT : PLINTH BEAM PLAN OF UNLOADING AND WASHING BAY		DWG.NO.: 01	SCALE		

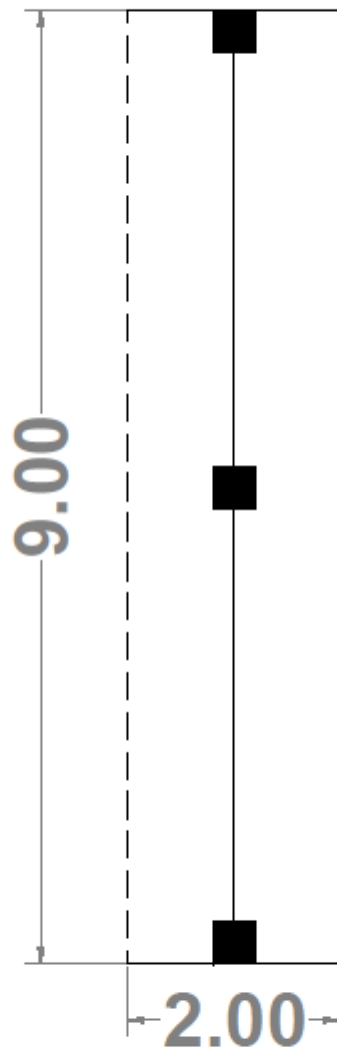

PLAN OF UNLOADING AND WASHING BAY + 00 LVL

PROJECT: PROPOSED PROJECT OF UNLOADING AND WASHING SAAT DUGH		TITLE: PLAN OF UNLOADING AND WASHING BAY		CLIENT:-	
DAIRY CAMPUS UNDER INDORE SAHKARI DUGH SANGH MARYADIT INDORE(M.P)		DATE: 1/10/2018	DWG.BY:	N 	CONSULTANTS/ARCHITECT MARIGO CONSULTANTS <small>ENGINEERS, ARCHITECTS AND PROJECT CONSULTANTS 304, PULGAO ACHARYA STREET, AMRITNAGAR A.P. ROAD, INDORE-492007</small>
CLIENT : INDORE SAHKARI DUGH SANGH MARYADIT INDORE(M.P)		DWG.NO. 01	SCALE		

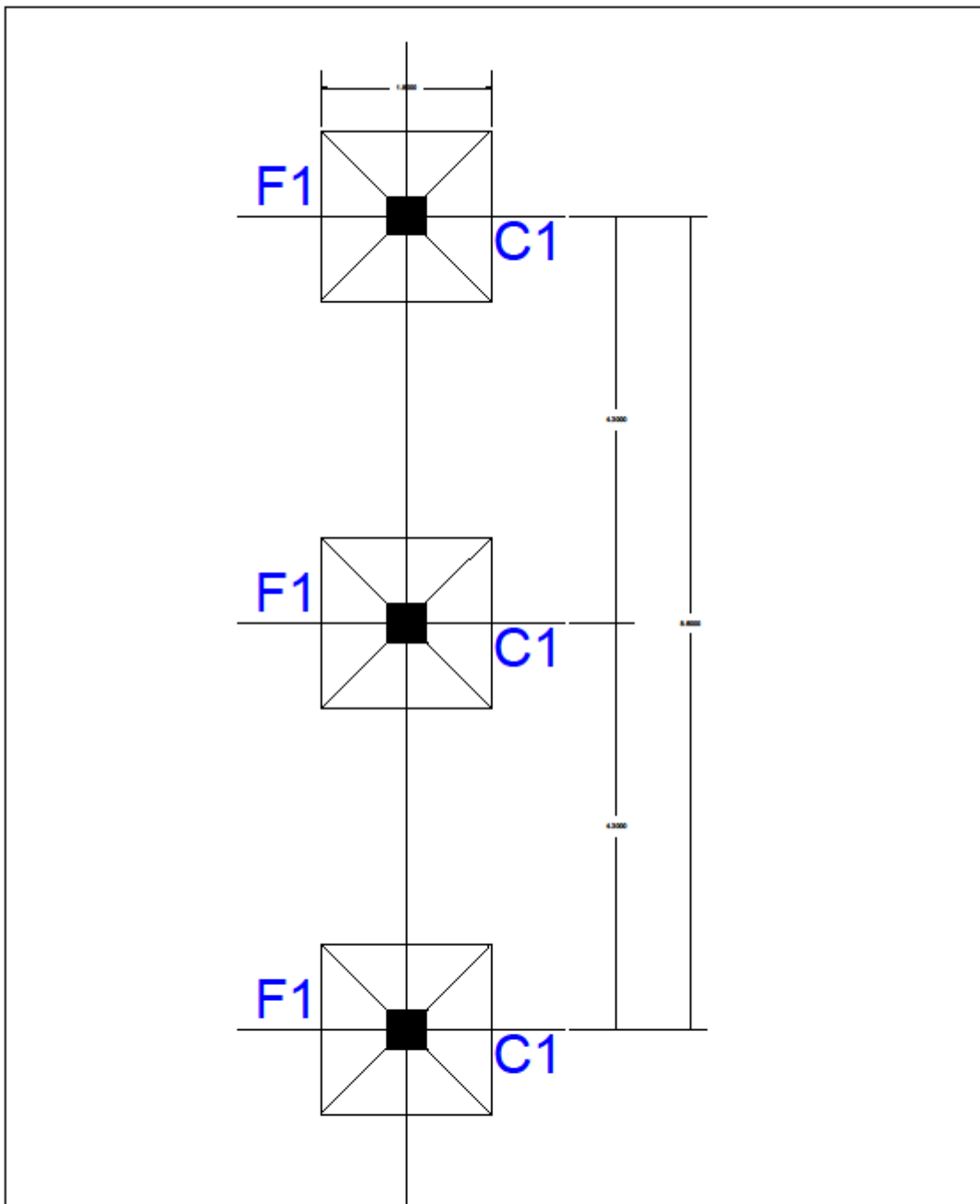

(CENTER LINE PLAN)

PROJECT: PROPOSED PROJECT OF UNLOADING AND WASHING BAY DUGH		TITLE: BEAM PLAN		CLIENT:-	
DARY CAMPUS UNDER INDORE SAHKARI DUGH SANGH MARYADIT INDORE(M.P)		DATE: 1/02/2017	DWG.BY:	N	CONSULTANT/ARCHITECT
INDORE SAHKARI DUGH SANGH MARYADIT INDORE(M.P)					
CLIENT : PLINTH BEAM PLAN OF UNLOADING AND WASHING BAY		DWG.NO. 01	SCALE		MARIGO CONSULTANTS <small>ENGINEERS/ARCHITECTS/INTERIOR DESIGNERS</small> <small>204/103/02 AT ARTMET ANANDNAGAR</small> <small>A.S. ROAD INDORE (M.P.)</small>

FOOTING DETAIL

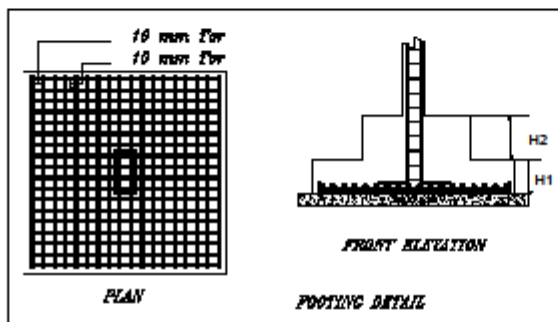

PARTI-CULAR	P.C.C. SIZE			GRADE	FOOTING SIZE		BARAT X DIRECTION		BARAT Y DIRECTION		HOOK	H1
	LENGTH X	BREATH Y	THIK		LENGTH	BREADTH	DIA.	NOS	DIA.	NOS		
F1	2000	2000	150	M-10	1800	1800	10 TOR	150C/C	10 TOR	150C/C	75 mm	200



FOOTING DETAIL-F1

COULMN DETAIL

PARTI-CULAR	COLUMN SIZE		MAIN REINFORCEMENT		RING SIZE		RING SPACING		CONC. GRADE	REMARK	SYMBOL	NO.
	WIDTH	BREADTH	DIA.	NOS	WIDTH	BREADTH	DIA.	SPACING				
C1	400	400	16 TOR	8 nos.	320	320	8 MM	125 mm C/C	M-20	ALT. CUTRING		3

PROJECT: PROPOSED PROJECT OF UNLOADING AND WASHING BAAT DUGDH	TITLE: FOOTING AND COULMN DETAIL DRAWING	CLIENT:-
DAIRY CAMPUS UNDER INDORE SAHKARI DUGDH SANGH MARYADIT INDORE(M.P)	DATE: 1/02/2019	
INDORE SAHKARI DUGDH SANGH MARYADIT INDORE(M.P)	DWG.BY:	
CLIENT : PLINTH BEAM PLAN OF UNLOADING AND WASHING BAY	DWG.NO: 01	

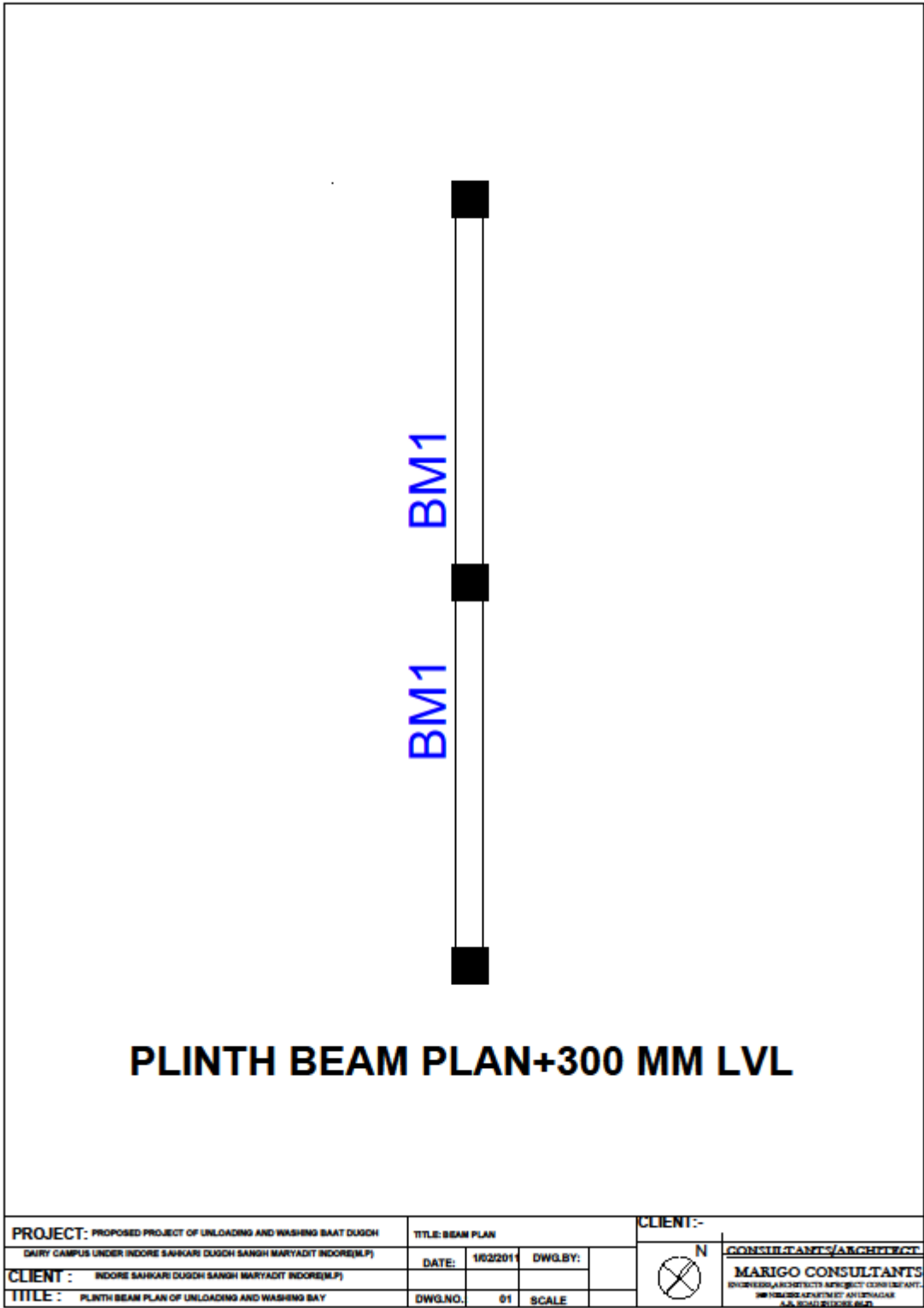

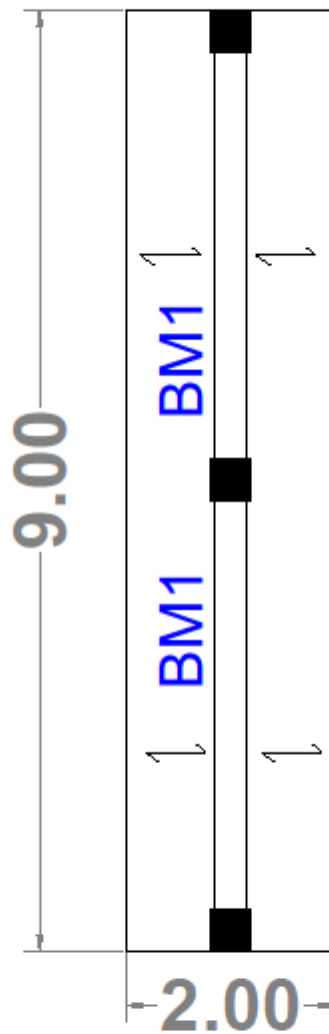

BEAM PLAN+2500 MM LVL

PROJECT: PROPOSED PROJECT OF UNLOADING AND WASHING SAAT DUGH		TITLE: BEAM PLAN		CLIENT:-	
DARY CAMPUS UNDER INDORE SAHKAR DUGH SANGH MARYADIT INDORE(M.P)		DATE: 1/02/2011	DWG.BY:		CONSULTANTS/ARCHITECT MARIGO CONSULTANTS <small>ENGINEERS/ARCHITECTS/INTERIOR DESIGNERS</small> <small>101/102/103/104/105/106/107/108/109/110/111/112/113/114/115/116/117/118/119/120/121/122/123/124/125/126/127/128/129/130/131/132/133/134/135/136/137/138/139/140/141/142/143/144/145/146/147/148/149/150/151/152/153/154/155/156/157/158/159/160/161/162/163/164/165/166/167/168/169/170/171/172/173/174/175/176/177/178/179/180/181/182/183/184/185/186/187/188/189/190/191/192/193/194/195/196/197/198/199/200/201/202/203/204/205/206/207/208/209/210/211/212/213/214/215/216/217/218/219/220/221/222/223/224/225/226/227/228/229/230/231/232/233/234/235/236/237/238/239/240/241/242/243/244/245/246/247/248/249/250/251/252/253/254/255/256/257/258/259/260/261/262/263/264/265/266/267/268/269/270/271/272/273/274/275/276/277/278/279/280/281/282/283/284/285/286/287/288/289/290/291/292/293/294/295/296/297/298/299/300/301/302/303/304/305/306/307/308/309/310/311/312/313/314/315/316/317/318/319/320/321/322/323/324/325/326/327/328/329/330/331/332/333/334/335/336/337/338/339/340/341/342/343/344/345/346/347/348/349/350/351/352/353/354/355/356/357/358/359/360/361/362/363/364/365/366/367/368/369/370/371/372/373/374/375/376/377/378/379/380/381/382/383/384/385/386/387/388/389/390/391/392/393/394/395/396/397/398/399/400/401/402/403/404/405/406/407/408/409/410/411/412/413/414/415/416/417/418/419/420/421/422/423/424/425/426/427/428/429/430/431/432/433/434/435/436/437/438/439/440/441/442/443/444/445/446/447/448/449/450/451/452/453/454/455/456/457/458/459/460/461/462/463/464/465/466/467/468/469/470/471/472/473/474/475/476/477/478/479/480/481/482/483/484/485/486/487/488/489/490/491/492/493/494/495/496/497/498/499/500/501/502/503/504/505/506/507/508/509/510/511/512/513/514/515/516/517/518/519/520/521/522/523/524/525/526/527/528/529/530/531/532/533/534/535/536/537/538/539/540/541/542/543/544/545/546/547/548/549/550/551/552/553/554/555/556/557/558/559/560/561/562/563/564/565/566/567/568/569/570/571/572/573/574/575/576/577/578/579/580/581/582/583/584/585/586/587/588/589/590/591/592/593/594/595/596/597/598/599/600/601/602/603/604/605/606/607/608/609/610/611/612/613/614/615/616/617/618/619/620/621/622/623/624/625/626/627/628/629/630/631/632/633/634/635/636/637/638/639/640/641/642/643/644/645/646/647/648/649/650/651/652/653/654/655/656/657/658/659/660/661/662/663/664/665/666/667/668/669/670/671/672/673/674/675/676/677/678/679/680/681/682/683/684/685/686/687/688/689/690/691/692/693/694/695/696/697/698/699/700/701/702/703/704/705/706/707/708/709/710/711/712/713/714/715/716/717/718/719/720/721/722/723/724/725/726/727/728/729/730/731/732/733/734/735/736/737/738/739/740/741/742/743/744/745/746/747/748/749/750/751/752/753/754/755/756/757/758/759/760/761/762/763/764/765/766/767/768/769/770/771/772/773/774/775/776/777/778/779/780/781/782/783/784/785/786/787/788/789/790/791/792/793/794/795/796/797/798/799/800/801/802/803/804/805/806/807/808/809/810/811/812/813/814/815/816/817/818/819/820/821/822/823/824/825/826/827/828/829/830/831/832/833/834/835/836/837/838/839/840/841/842/843/844/845/846/847/848/849/850/851/852/853/854/855/856/857/858/859/860/861/862/863/864/865/866/867/868/869/870/871/872/873/874/875/876/877/878/879/880/881/882/883/884/885/886/887/888/889/890/891/892/893/894/895/896/897/898/899/900/901/902/903/904/905/906/907/908/909/910/911/912/913/914/915/916/917/918/919/920/921/922/923/924/925/926/927/928/929/930/931/932/933/934/935/936/937/938/939/940/941/942/943/944/945/946/947/948/949/950/951/952/953/954/955/956/957/958/959/960/961/962/963/964/965/966/967/968/969/970/971/972/973/974/975/976/977/978/979/980/981/982/983/984/985/986/987/988/989/990/991/992/993/994/995/996/997/998/999/1000</small>
INDORE SAHKARI DUGH SANGH MARYADIT INDORE(M.P)					
CLIENT : PLINTH BEAM PLAN OF UNLOADING AND WASHING BAY		DWG.NO. 01	SCALE		

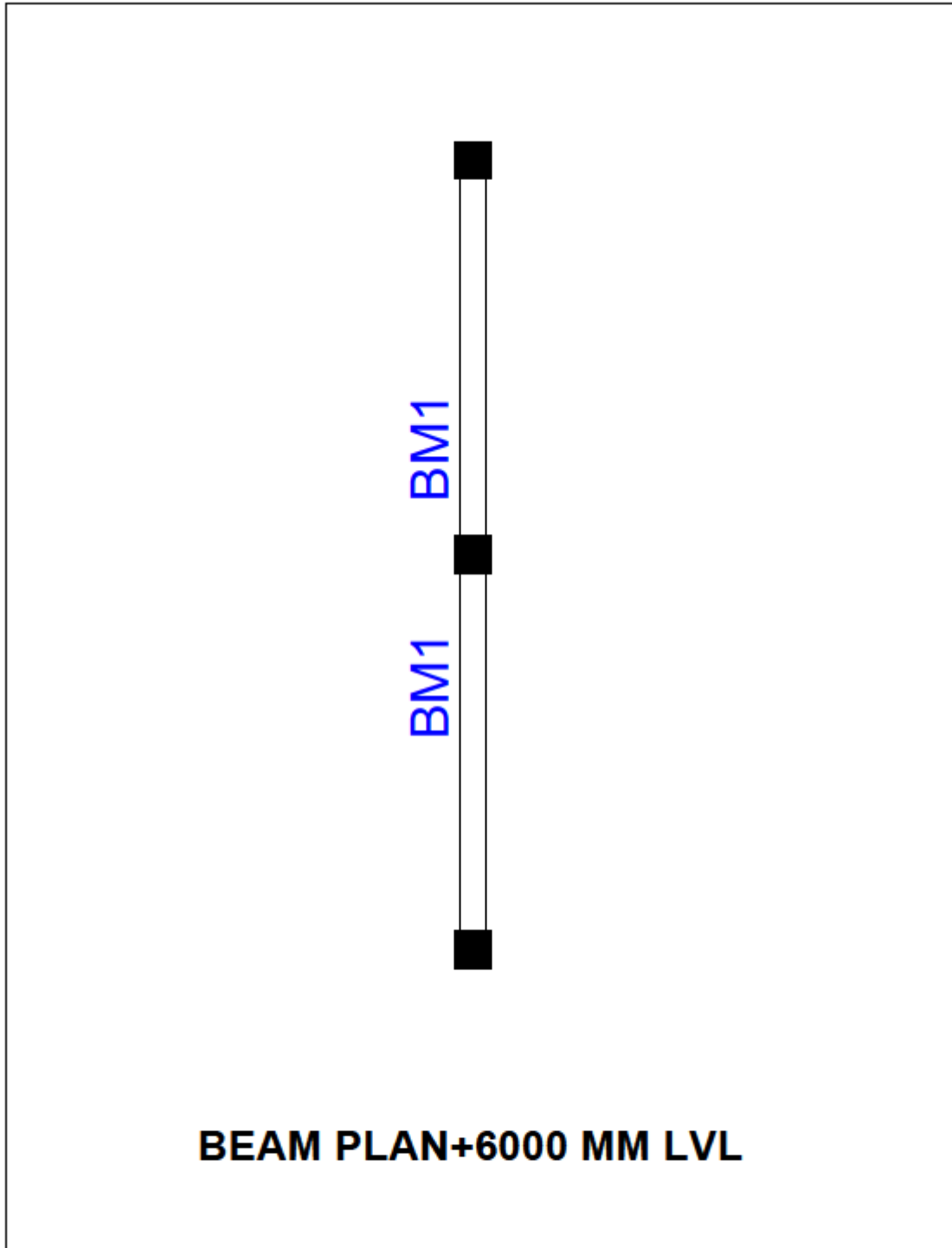

BEAM PLAN+6000 MM LVL

PROJECT: PROPOSED PROJECT OF UNLOADING AND WASHING BAAT DUGH		TITLE: BEAM PLAN		CLIENT:-	
DAIRY CAMPUS UNDER INDORE SAHKARI DUGH SANSH MARYADI INDORE(M.P)		DATE: 10/2/2019	DWG.BY:		CONSULTANT: MARIGO CONSULTANTS <small>ENGINEERS, ARCHITECTS & PROJECT CONSULTANTS</small> <small>100, INDORE APARTMENT, INDORE NAGAR</small> <small>44, BHADRAKUMAR</small>
INDORE SAHKARI DUGH SANSH MARYADI INDORE(ICP)		DWG.NO. 01	SCALE		
CLIENT : PLINTH BEAM PLAN OF UNLOADING AND WASHING BAY					

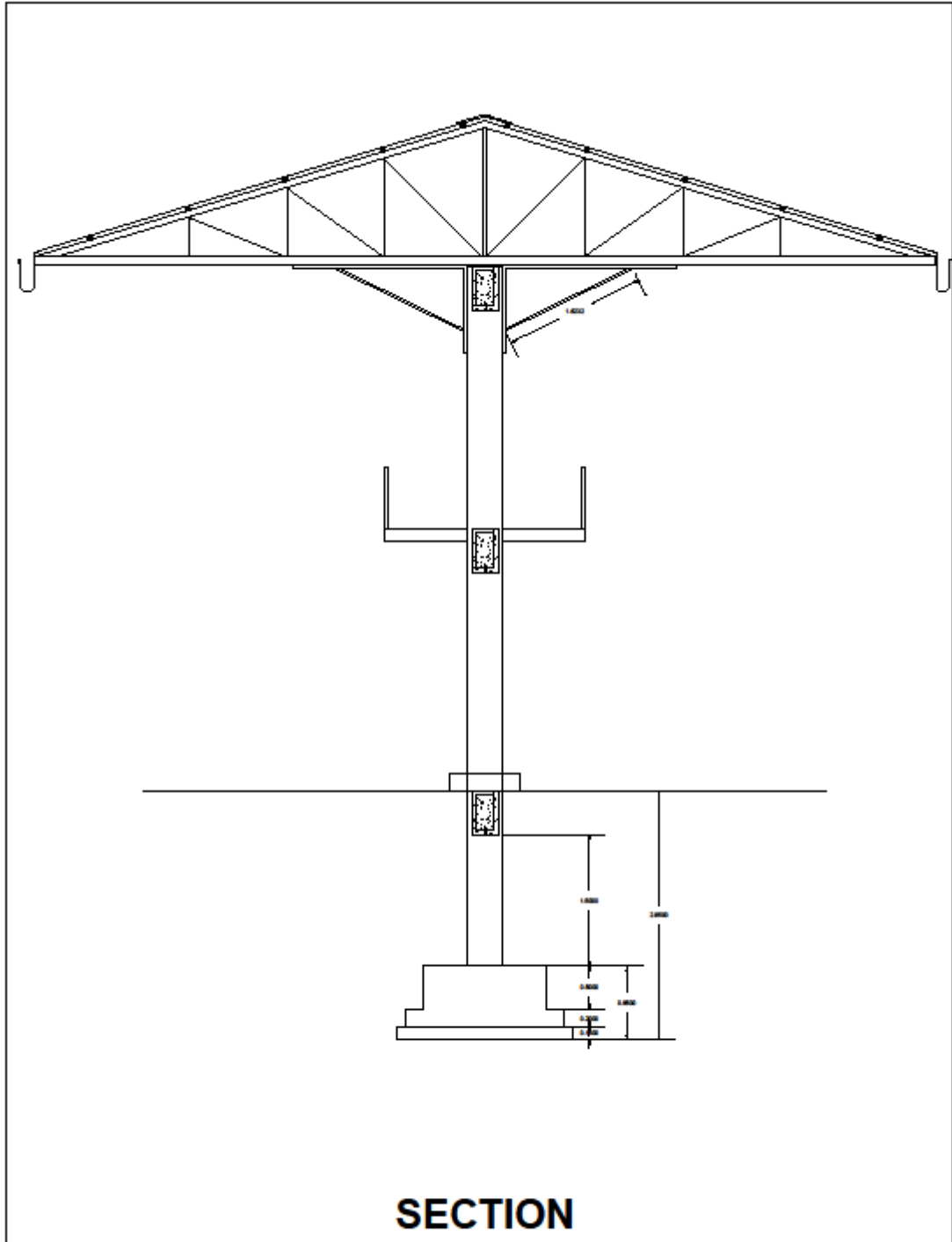

PROJECT: PROPOSED PROJECT OF UNLOADING AND WASHING BAAT DUGH		TITLE: SECTION		CLIENT:-	
DAIRY CAMPUS UNDER INDORE SAHKARI DUGH SANGH NARYADIT INDORE(M.P)		DATE: 1/02/2011	DWG.BY:	CONSULTANTS/ARCHITECT MARIGO CONSULTANTS <small>INDIAN ARCHITECTS ASSOCIATION REGISTERED ARCHITECTS 108, VEDANT SQUARE, SURYAPURAM, A.S. ROAD, CHENNAI (M.P)</small>	
INDORE SAHKARI DUGH SANGH NARYADIT INDORE(M.P)					
CLIENT : PLINTH BEAM PLAN OF UNLOADING AND WASHING BAY		DWG.NO. 01	SCALE		

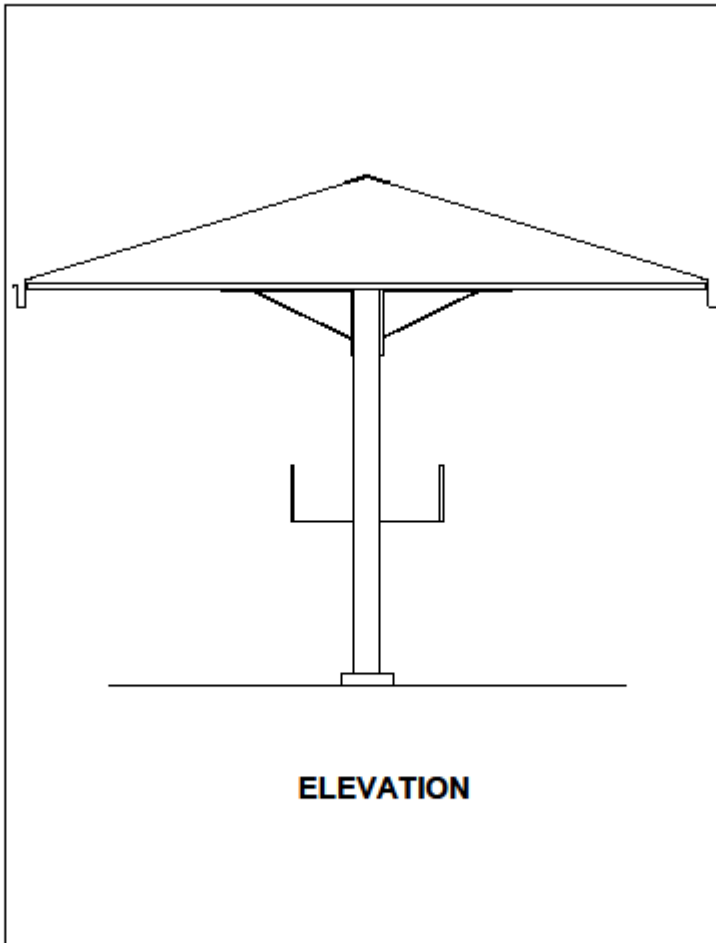

ELEVATION

PROJECT: PROPOSED PROJECT OF UNLOADING AND WAREHOUSING BAIT (MARIJUANA)		TITLE: SIGNAGE		CLIENT:	
BAPT CAMPUS UNDER THE ROADS (BAPTIST CHURCH BAPTIST SOCIETY)		DATE:	ISSUED:	DRAWN BY:	 MARIJO CONSULTANCY <small>ARCHITECTURAL SERVICES AND DESIGN</small>
BAPT CAMPUS UNDER THE ROADS (BAPTIST CHURCH BAPTIST SOCIETY)		DWG. NO:	01	SCALE:	

BEAM DETAIL

BEAM	SIZE (mm)	MAIN REINFORCEMENT				SHEAR REINF (TLS)	REMARKS
		TOP TH	TOP EXTRA	BTM TH	BTM EXTRA		
BM1	300X500	2-12mm	2-16mm	2-16mm	2-16mm	8mm@125/175mm	AT JUNCTION OF BEAMS SHEAR REL AS AT SUPPORT

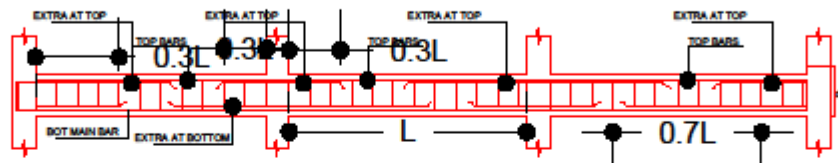

TYPICAL SECTION OF BEAM REINFORCEMENT

CANTILEVER SLAB DETAIL

PARTICULAR	THICK	GRADE	MAIN REINFORCEMENT (CANTILEVER)		DISTRIBUTION BAR		REMARK
			DIA	SPACING	DIA	SPACING	
SLAB (S1)	125 MM	M-30	10 TOR	125 MM C/C	8 TOR	160 MM	ONE-WAY

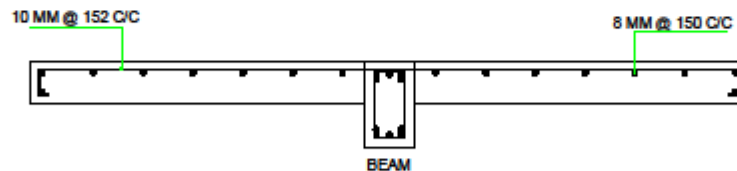

(SLAB 1) BEAM SLAB DETAIL (150 MM THK.)

BEAM & SLAB DETAIL

PROJECT: PROPOSED PROJECT OF UNLOADING AND WASHING BAAT DUGDH DAIRY CAMPUS UNDER INDORE SAHKARI DUGDH SANGH MARYADIT INDORE(M.P)		TITLE: PLINTH BEAM AND SLAB DETAIL DRAWING		CLIENT:-	
INDORE SAHKARI DUGDH SANGH MARYADIT INDORE(M.P)		DATE: 1/02/2019	DWG.BY:	N 	CONSULTANTS/ARCHITECT MARIGO CONSULTANTS ENGINEERS, ARCHITECTS & PROJECT CONSULTANTS 240 HELDEN APARTMENT ANUPPAPGAR A.S. ROAD INDORE (M.P)
CLIENT: PLINTH BEAM PLAN OF UNLOADING AND WASHING BAY		DWG.NO.: 01	SCALE:		

Details of Milestones

Construction cover shed of Washing bay Platform District - Indore (M.P.)

The time allowed for the carrying out the work, as entered in the tender form shall be strictly observed by the contractor and shall be deemed to be essence of the contract and shall be reckoned immediately from the date of signing of agreement to commence the work issued to the contractor.

The work shall throughout the stipulated period of contract be proceeded with all due diligence keeping in view that time is the essence of the contract. The contractor shall be bound in all cases, to complete the following financial target,

- 1/8th of the whole work before 1/4th of the whole time allowed under the contract has elapsed,
- 3/8th of the work before 1/2 of such time has elapsed
- 3/4th of the work before 3/4 of such time has elapsed.

Compensation for Delay

If the contractor fails to achieve the milestones, and the delay in execution of work is attributable to the contractor, the Employer shall retain an amount from the sums payable and due to the contractor as per following scale -

- i. Slippage up to 25% in financial target during the milestone under consideration -2.5% of the work remained unexecuted in the related time span.
- ii. Slippage exceeding 25% but Up to 50% in financial target during the milestone under consideration -5% of the work remained unexecuted in the related time span.
- iii. Slippage exceeding 50% but Up to 75% in financial target during the milestone under consideration -7.5% of the work remained unexecuted in the related time span.
- iv. Slippage exceeding 75% in financial target during the milestone under consideration - 10% of the work remained unexecuted in the related time span.

Note: For arriving at the dates of completion of time span related to different milestones, delays which are not attributable to the Contractor shall be considered. The slippage on any milestone is if made good in subsequent milestones or at the time of stipulated period of completion, the amount retained as above shall be refunded. In case the work is not completed within the stipulated period of completion along with all such extensions which are granted to the Contractor for either Employer's default or Force Majeure, the compensation shall be levied on the contractor at the rate of 0.05% per day of delay limited to a maximum of 10% of contract price.

The decision of Employer shall be final and binding upon both the parties.

List of Equipment for Quality Control Lab

As per Annexure-I (Format I-4)

Bank Guarantee Form for Mobilization Advance

To

_____ [name of Employer]
_____ [address of Employer] _____ [name of Contractor]

In accordance with the provisions of the General Conditions of Contract, clause 31 ("Mobilization and Construction Machinery Advance") of the above-mentioned Contract _____ [name and address of Contractor] (hereinafter called "the Contractor") shall deposit with _____ [name of Employer] a bank guarantee to guarantee his proper and faithful performance under the said Clause of the Contract in an amount of _____ [amount of Guarantee]* _____ [in words].

We, the _____ [bank of financial institution], as instructed by the Contractor, agree unconditionally and irrevocably to guarantee as primary obligator and not as surety merely, the payment to _____ [name of Employer] on his first demand without whatsoever right of obligation on our part and without his first claim to the Contractor, in the amount not exceeding _____ [amount of guarantee]* _____ [in words].

We further agree that no change or addition to or other modification of the terms of the Contractor or Works to be performed there under or of any of the Contract documents which may be made between _____ [name of Employer] and the Contractor, shall in any way release us from any liability under this guarantee, and we hereby waive notice of any such change, addition or modification.

This guarantee shall remain valid and in full effect from the date of the advance payment under the Contract until _____ [name of Employer] receives full repayment of the same amount from the Contractor.

Yours truly,

Signature and Seal : _____

Name of Bank/Financial Institution: _____ Address :

_____ Date : _____

* An amount shall be inserted by the Bank or Financial Institution representing the amount of the Advance Payment, and denominated in Indian Rupees.

Bank Guarantee Form for Secured Advance - DELETED

Physical Completion Certificate

Name of Work:

.....
.....
.....

Agreement No. Date

Amount of Contract Rs

Name of Agency :

Used MB No. -----

Last measurement recorded

- a. Page No. & MB No. _____
- b. Date _____

Certified that the above mentioned work was physically completed on (date) and taken over on (date) and that I have satisfied myself to best of my ability that the work has been done properly.

Date of issue

Chief Executive Officer
Indore dugdh sangh indore

Final Completion Certificate

Name of Work: **Construction cover shed of Washing bay Platform at ISDSM Indore District - Indore (M.P.)**

Agreement no. Date

Name of Agency :

Used MB No. -----

Last measurement recorded

a. Page No. & MB No. _____

b. Date _____

Certified that the above mentioned work was physically completed on (date) and taken over on (date).

Agreement amount Rs.

Final Amount paid to contractor Rs.

Incumbency of officers for the work

I have satisfied myself to best of my ability that the work has been done properly.

Date of issue

Chief Executive Officer
Indore dugdh sangh indore

Salient Features of Some Major Labour Laws Applicable

- a) **Workmen Compensation Act 1923:** The Act provides for compensation in case of injury by accident arising out of and during the course of employment.
- b) **Payment of Gratuity Act 1972:** Gratuity is payable to an employee under the Act on satisfaction of certain conditions on separation if an employee has completed the prescribed minimum years (say, five years) of service or more or on death the rate of prescribed minimum days'(say, 15 days) wages for every completed year of service. The Act is applicable to all establishments employing the prescribed minimum number (say, 10) or more employees.
- c) **Employees P.F. and Miscellaneous Provision Act 1952:** The Act Provides for monthly contributions by the Employer plus workers at the rate prescribed (say, 10% or 8.33%). The benefits payable under the Act are:
 - i. Pension or family pension on retirement or death as the case may be.
 - ii. Deposit linked insurance on the death in harness of the worker.
 - iii. Payment of P.F. accumulation on retirement/death etc.
- d) **Maternity Benefit Act 1951:** The Act provides for leave and some other benefits to women employees in case of confinement or miscarriage etc.
- e) **Contract Labour (Regulation & Abolition) Act 1970:** The Act provides for certain welfare measures to be provided by the Contractor to contract labour and in case the Contractor fails to provide, the same are required to be provided by the Principal Employer by Law. The principal Employer is required to take Certificate of Registration and the Contractor is required to take license from the designated Officer. The Act is applicable to the establishments or Contractor of Principal Employer if they employ prescribed minimum (say 20) or more contract labour.
- f) **Minimum Wages Act 1948:** The Employer is to pay not less than the Minimum Wages fixed by appropriate Government as per provisions of the Act if the employment is a scheduled employment. Construction of buildings, roads, runways is scheduled employment.
- g) **Payment of Wages Act 1936:** It lays down as to by what date the wages are to be paid, when it will be paid and what deductions can be made from the wages of the workers.
- h) **Equal Remuneration Act 1979:** The Act provides for payment of equal wages for work of equal nature to male and female workers and for not making discrimination against female employees in the matters of transfers, training and promotions etc.
- i) **Payment of Bonus Act 1965:** The Act is applicable to all establishments employing prescribed minimum (say 20) or more workmen. The Act provides for payments of annual bonus within the prescribed range of percentage of wages to employees drawing up to

the prescribed amount of wages, calculated in the prescribed manner. The Act does not apply to certain establishments. The newly set-up establishments are exempted for five years in certain circumstances. States may have different number of employment size.

- j) **Industrial Disputes Act 1947:** The Act lays down the machinery and procedure for resolution of industrial disputes, in what situations a strike or lock-out becomes illegal and what are the requirements for laying off or retrenching the employees or closing down the establishment.
- k) **Industrial Employment (Standing Orders) Act 1946:** It is applicable to all establishments employing prescribed minimum (say, 100, or 50). The Act provides for laying down rules governing the conditions of employment by the Employer on matters provided in the Act and gets these certified by the designated Authority.
- l) **Trade Unions Act 1926:** The Act lays down the procedure for registration of trade unions of workmen and Employers. The Trade Unions registered under the Act have been given certain immunities from civil and criminal liabilities.
- m) **Child Labour (Prohibition & Regulation) Act 1986:** The Act prohibits employment of children below 14 years of age in certain occupations and processes and provides for regulations of employment of children in all other occupations and processes. Employment of child labour is prohibited in building and construction industry.
- n) **Inter-State Migrant Workmen's (Regulation of Employment & Conditions of Service) Act 1979:-** The Act is applicable to an establishment which employs prescribed minimum (say, five) or more inter-state migrant workmen through an intermediary (who has recruited workmen in one state for employment in the establishment situated in another state). The Inter-State migrant workmen, in an establishment to which this Act becomes applicable, are required to be provided certain facilities such as Housing, Medical-Aid, Travelling expenses from home up to the establishment and back etc.
- o) **The Building and Other Construction workers (Regulation of Employment and Conditions of Service) Act 1996 and the Cess Act of 1996:** All the establishments who carry on any building or other construction work and employs the prescribed minimum (say, 10) or more workers are covered under this Act. All such establishments are required to pay cess at the rate not exceeding 2% of the cost of construction as may be modified by the Government. The Employer of the establishment is required to provide safety measures at the building or construction work and other welfare measures such as canteens, first-aid facilities, ambulance, housing accommodations for workers near the work place etc. The Employer to whom the Act applies has to obtain a registration certificate from the Registering Officer appointed by the Government.
- p) **Factories Act 1948:** The Act lays down the procedure for approval of plans before setting up a factory, health and safety provisions, welfare provisions, working hours, annual earned leave and rendering information regarding accidents or dangerous occurrences to designated authorities. It is applicable to premises employing the prescribed minimum (say, 10) persons or more with aid of power or another prescribed minimum (say, 20) or more persons without the aid of power engaged in manufacturing process.

SECTION 3

Conditions of Contract

Part – II Special Conditions of Contract [SCC]

1.0 General

- 1.1 Subject to the nomenclature of the item and the specifications indicated hereafter, the work, in general, shall be carried out in accordance with the UADD ISSR 2012, CPWD Specifications and National Building Code of India read with correction slips issued up to the date of receipt of tenders and relevant IS Codes.
- 1.2 Wherever reference to any Indian standard specification occurs in the documents relating to this contract, the same shall be inclusive of all amendments issued thereto or revisions thereof, if any, up to the date of receipt of tenders.
- 1.3 Before commencement of the work, the successful bidder shall co-relate nomenclature of the items with all the relevant architectural and structural drawings to satisfy himself that the information available there from is complete and unambiguous. The figures and written dimensions on the drawings shall be followed. The dimensions shall not be scaled out. The contractor shall submit for approval of Engineer-in-Charge his workshop / fabrication drawings and the sample of work to be performed under the specified items of work before actually commencing the mass execution of work under the item. Nothing extra shall be payable on this account.
- 1.4 The contractor shall prepare and submit all shop drawings and Bar Bending Schedule to Engineer-in-Charge for approval prior to commencement of work.
- 1.5 The discrepancy in the drawings issued, if any, shall be brought to the notice of Engineer-in-Charge and architect for immediate decision before execution of the work. The contractor, alone, shall be responsible for any loss or damage occurring by the commencement of work on the basis of any erroneous information and no claim whatsoever, shall be entertained on this account.
- 1.6 In the event of any difference or discrepancy in the description of any item or its specifications, the same shall be resolved in the following sequence and decision of the Engineer-in-charge shall be conclusive, final and binding on the contractor:
 - a) The nomenclature of the item shall take precedence over all and anything stated elsewhere.
 - b) The conditions and specifications attached to the tender documents shall take precedence over the provisions of PWD ISSR 2014 with amendment up to date correction slips and relevant IS Codes.
 - c) The PWD ISSR 2014 with amended correction slip up to the date of receipt of tender shall take precedence over provisions of relevant IS Codes.
 - d) In case, it is not possible to resolve the issue with the help of tender documents, the provisions of relevant IS Codes shall be relied upon.

- e) In case, it is not possible to resolve issue with the help of any of the above stated documents, the decision and directions of the Engineer-in-charge shall be followed for execution and completion of any item of work.
- 1.7 The tenderer shall acquaint himself with the proposed site of work, its sub soil strata, soil investigating reports, underground water tables and its approach roads before quoting his rates. The construction of new approach road or repair of the existing approach and its maintenance during the execution of the work shall all be carried out by the contractor and nothing extra shall be payable over his quoted rates.
2. If for any reasons, any part of the site is not available temporarily for some time for part of the work under the contract, the agreed construction schedule shall be suitably modified and contractor shall diligently divert his men and materials to utilize them appropriately, profitably and no claim of damages whatsoever shall be entertained on this account. However, the contractor shall be allowed extension of time for completing the work as deemed fit by the competent authority. The contractor shall also not be entitled to any compensation for any loss suffered by him and revision in the rates quoted by him:
- a) On account of delay in commencing the work by the contractor
- b) On account of reduction in the scope of work.
- c) On account of suspension of work or abandoned after award of work.
3. The contractor shall make his own arrangement for obtaining electric connection required for execution of work and make necessary payments directly to the concerned departments and nothing extra shall be payable on this account.
4. The contractor shall make his own arrangement for water suitable for construction. The water for construction work shall be got tested quarterly from the laboratory approved by the Engineer-in-charge to ensure its suitability for construction. The charges for these tests and related arrangements shall be borne by the Contractor. In the event of water being found unsuitable for construction, the contractor shall make alternative arrangement for suitable water from any other source to the satisfaction of the Engineer-in-charge. However, the contractor shall not be paid extra on this account.
5. The contractor shall construct a sample (mock up) unit and make of samples of different activities complete in all respect as per the directions of the Engineer-in-charge and Architect. This sample unit shall be got approved from the Engineer-in-charge and Architect before commencing the mass work.
6. The contractor shall take care of all safety precautions pertaining to construction works, such as scaffolding, ladder, working platforms, gangways, electric arc/ gas welding, use of hoist and construction machinery.
7. On account of security consideration, some restrictions may be imposed by the security staff on the working movement of men and materials etc. The contractor shall be bound to follow all such restrictions/ instructions and he shall organize his work accordingly. No claim on this account, whatsoever, shall be payable.

8. The contractor shall take all precautions to avoid accidents by exhibiting necessary caution boards during day and night, speed limit boards, red flags, red lights and providing barriers. He shall be responsible for all damages and accidents caused to existing/ new work due to negligence on his part. No hindrance shall be caused to traffic during the execution of the work.
9. The Contractor shall take full responsibility for the care of the works and materials and Plant for in COUNCIL therein from the Commencement Date until the date of issue of the Taking-Over Certificate for the whole of the works, when the responsibility for the said care shall pass to the Employer. The contractor shall be responsible for the watch and ward of the building safety of all fittings and fixtures including sanitary and water supply fittings and fixtures against pilferage and breakage during the period of installation and thereafter till the building is physically handed over to the department. Provided that the Engineer issues a Taking-Over Certificate for any Section or part of the Permanent Works, the Contractor shall cease to be liable for the care of that Section or part from the date of issue of the Taking-Over Certificate.
10. The contractor shall take all preventive measures against any damage caused by rain, snowfall, floods or any other natural calamity, whatsoever, during the execution of the work. The contractor shall be fully responsible for any damage to the Owner's property and to the work for which the payment has been advanced to him under the contract. This will also cover the defect liability period. Nothing extra on this account shall be payable to the contractor for maintaining such Insurance Policy.
11. According to below given details the following Construction works are to be incorporated in Civil tender:
 1. Masonry works for Foundations for equipment which will be proposed by mechanical supplier are to be considered for which drawings showing pockets shall be given to Civil contractor before final concreting of floor slab..
12. Scope of Work during Defect Liability Period
 - A) **Defect Liability Period shall be of 12 Month (Twelve months)** after issuance physical completion certificate of work for the entire works (except water proofing and termite treatment) by the competent authority of the project. The scope of work during this period shall be as follows:-
 - 1) The cost of maintenance shall be deemed to be included in tender and nothing extra shall be paid.
 - 2) Remove defects observed during this period in all permanent structures, drains etc. completely.
 - 3) If any item has manufacturing defect, contractor shall replace the same at his own cost. If it is damaged by any other means, the fixtures/ fittings shall be provided by the Department, and the same shall be installed by contractor at his own cost.
13. The work shall be carried out, complying in all respects, with the requirements of relevant bye-laws of the local body under the jurisdiction of which the work is to be executed,

specifications, conditions of contract, drawings or as directed by the Engineer-in-Charge and nothing extra shall be paid on this account.

14. The contractor shall comply with proper and legal orders and directions of the local or public authority or municipality and abide by their rules and regulations and pay all fees and charges which may be liable.
15. The contractor shall give due notices to Municipal, Police and/or other authorities that may be required under the law/rules under force in the area and obtain all requisite licenses for temporary obstructions / enclosures and pay all charges which may be levied on account of his execution of work under the agreement. Nothing extra shall be payable on this account.
16. Materials to be incorporated in the work shall be arranged by the contractor and shall be in accordance with the specifications and bearing ISI Certification Mark only unless otherwise specified or allowed in writing by the Engineer-in-Charge. Any material banned by the department shall not be used in the work. In case of specific items the material shall be in accordance with the enclosures approved items.
17. The contractor shall submit to the Engineer-in-charge and Architect samples of all materials for approval. Such samples of materials which affect aesthetics of the work shall also be got approved from the Engineer-in-charge and Architect of the project before procuring bulk supplies. These approved samples shall be preserved and retained in the custody of the Engineer-in-charge as standards of materials till the completion of the work. The cost of such samples shall be borne by the Contractor and nothing shall be payable on this account over the Agreement rates.
18. The contractor shall be required to get all the necessary mandatory and other tests as per the specifications/ IS codes, carried out on materials/ work from an approved laboratory as per the direction of the Engineer-in-charge. The testing charges and conveyance from the site shall be borne by the contractor.
19. In case any material, work is found sub-standard the same shall be rejected by the Engineer-in-charge/ Architect representative and the same shall be removed from the site of work within 48 hours, failing which the same shall be got removed by the Engineer-in-charge at the risk and cost of the contractor without giving any further notice and time.
20. The treads and risers in staircase, door & window sills shall be in single piece stone only, unless otherwise shown on the drawings or as directed by Engineer-in-Chief & Architect.
21. In order to ensure quality of work during its execution, the Engineer-in-charge and Architect representative may require samples for mandatory or routine testing of materials. All costs of these samples, their packaging, conveyance from the site to the testing laboratory and return, shall be borne by the contractor.
22. Even ISI marked materials may be subjected to quality test at the discretion of the Engineer-in-charge/ Architect. Whenever ISI marked materials are brought to the site of work the contractor shall, if required by the Engineer-in-charge/ Architect, furnish manufacturer's test certificate or test certificate from approved testing laboratory to establish that the materials procured by the contractor, satisfy the provisions of relevant ISI codes. The testing charges shall be borne by the contractor. However, cement/ steel will be necessarily tested before

start of work and also during the execution of work as per the requirements of specifications and will not be used until test certificates are obtained and approved by Engineer-in-Charge/ Architect

23. The contractor shall procure minimum 43 grade (conforming to IS:8112) Ordinary Portland Cement only as required for the work from the reputed manufacturers of cement, i.e. from A.C.C., J.P., Ultratech, J.K. or Birla only as approved by the employer. Supply of cement shall be taken in 50 kg bags bearing manufacturers name and ISI marking. Samples of cement arranged by the contractor shall be taken by the Engineer-in-charge and got tested in accordance with provisions of relevant IS codes. In case test results indicate that the cement arranged by the contractor does not conform to the relevant IS codes, the same shall stand rejected and shall be removed from the site by the contractor at his cost within a week's time of the written order from the Engineer-in-charge to do so.
- (i) The cement shall be brought at site in not less than 25 tons lots or as decided by the Engineer-in-charge / Architect.
 - (ii) The cement store room shall have a capacity of minimum of 500 bags of cement. The store should be constructed by the contractor at site of work for which no extra payment shall be made. The contractor shall be responsible for the watch and ward and safety of the cement store room. The contractor shall facilitate the inspection of the cement store room by the Engineer-in-charge at any time.
 - (iii) The contractor shall supply free of charge the cement/other material required for testing. The cost of tests shall be borne by the contractor.
 - (iv) The actual issue and consumption of cement on work shall be regulated and proper accounts should be maintained. The theoretical consumption of cement shall be worked out as per procedure prescribed in the contract and shall be governed by conditions laid therein.
 - (v) Cement brought to site and remaining unused after completion of work shall not be removed from site without written permission of the Engineer-in-charge at any time.
24. The contractor shall procure steel reinforcement bars TMT-FE-500 only (Thermo-Mechanically Treated bars) conforming to relevant IS codes from SAIL, TISCO, VAIZAG, RINL & Jindal only. Structural steel of main Producer TATA, SAIL & Jindal only shall be permitted for use. The contractor shall have to obtain and furnish test certificates to the Engineer-in-charge in respect of all supplies of steel brought by him to the site of work. Samples shall also be taken and got tested by the Engineer-in-charge as per the provision in this regard in relevant IS codes. In case the test results indicate that the steel arranged by the contractor does not conform to BIS codes the same shall stand rejected and shall be removed from the site of work by the contractor at his cost within a week's time from the written orders from the Engineer-in-charge to do so. The cost of steel, testing charges and to & fro cartage shall be borne by the contractor.
- (i) The steel reinforcement shall be stored by the contractor at site of work in such a way as to prevent distortion and corrosion and nothing extra shall be paid on this account. Bars of different sizes and lengths shall be stored separately to facilitate

easy counting and checking at any time as and when desired by the Engineer-in-charge/ Architect.

- (ii) The contractor shall supply free of charge the steel required for testing.
 - (iii) The actual issue and consumption of steel on work site shall be calculated and proper accounts shall be maintained. The theoretical consumption of steel shall be worked out as per the standard procedure and shall be governed by conditions laid therein.
 - (iv) Steel brought to site and steel remaining unused shall not be removed from site without the written permission of the Engineer-in-charge.
25. The work shall be executed and measured in metric system. The metric dimensions given in the schedule of quantities and drawing, etc. shall be followed. (The dimension in FPS units wherever indicated, is for guidance only). The figures in the drawings shall be followed.
 26. For measurement purpose the floor level shall mean the top surface of main structural RCC slabs of that floor and not the top of sunken floor of toilets or any other depressed floor.
 27. The contractor shall be responsible for completing the work and for satisfying all terms and conditions of the contract without any extra payment over his quoted rates unless otherwise specified. The contractor shall quote his rate for various items of work accordingly and no claim whatsoever shall be entertained for any incidental or extra work involved in the execution of the work as per nomenclature of the item and the specifications indicated in the tender documents.
 28. Subject to the nomenclature of the item as per schedule of quantities, the specification indicated in the tender documents, the rates quoted shall include cost of all materials including royalty and taxes if any, labor, sundry inputs, execution of work at all heights, levels, pattern and design for all leads, lifts and depths including overhead charges and contractor's profit. Nothing extra shall be paid on this account.
 29. The rate shall be inclusive of making design, pattern and execution of work as per Architectural and structural drawings, at all levels and heights.
 30. The rates shall be inclusive of making any holes in walls/ RCC work for fixing any fixture/ frame work and making good the structure to its original shape and finish.
 31. The rate of items of flooring shall be inclusive of work for sunken or depressed floors.
 32. The rate shall be inclusive of working under water and adverse or foul conditions and including pumping out or bailing out water, dewatering unless otherwise specified in the nomenclature. This will include water encountered from any source such as rains, floods and any other cause whatsoever and including sub-soil water.
 33. Other agencies doing works related with this project will also simultaneously execute the works and the contractor shall afford necessary co-ordination for unhindered completion of these sub-works.
 34. The contractor shall leave necessary holes, opening, etc. as may be directed by the Engineer-in-Charge for lying, burying or fixing, conduits, pipes, boxes, hooks, fans etc. Conduits for

electrical wiring/ cables shall be laid in a way that they leave enough space for concreting and do not adversely affect structural members.

35. The contractor shall give a satisfactory performance test of installations individually and as a whole to ensure their proper functioning before the work is finally declared and completed and accepted.
36. The contractor shall continue to maintain watch and ward to safeguard the Owner's property in his possession until the same is formally handed over as per directions of the Engineer-in-charge. Nothing extra shall be paid on this account.
37. All tools, plants and measuring or weighing equipments shall be arranged by the contractor himself and nothing extra shall be paid to the contractor on this account.
38. The contractor shall protect the adjoining buildings or works and the work under execution from fire and shall make adequate arrangements for fire protection and fire fighting and if any property is damaged by fire due to the negligence of the contractor, the same shall be made good by the contractor at his own cost to the complete satisfaction of Engineer-in-charge.
39. The contractor shall provide adequate lighting arrangements as approved by the Engineer-in-charge for carrying out the work during night time, if so required and also provide all other facilities for the labour employed to carry out the work as per direction of Engineer-in-Charge. Nothing extra shall be paid on this account
40. In order to achieve the targeted date of completion the contractor may have to work in multiple shifts, round the clock including public and gazetted holidays and nothing extra shall be paid on this account.
41. The contractor shall get the samples of all the materials to be used in the work approved from Engineer-in-Charge and Architect before going for bulk procurement. Bulk procurement shall be taken up only after obtaining approval from the Engineer-in-charge. Any delay in getting the samples approved shall be contractor's responsibility.
42. All materials, articles and workmanship shall be of respective best quality and kind for the class described in the schedule of quantities and specifications. All materials so used in different items of work shall be subject to the approval of the Engineer-in-charge and Architect.
43. The contractor shall be responsible for all statutory provisions and deductions towards ESI, PF or any other, as the case may be or any other levies and taxes shall be borne by the contractors.

Taxes: All duties and taxes including Commercial Tax, VAT, Works Contract Tax, Service Tax, TDS, Octroi, Duties, Royalties, Labour Welfare Cess and any other direct or indirect taxes and duties levied by the Central Government, State Government, Local Bodies and any other Government agency or private individuals on the contractor's work are inclusive in the contract/ tender price of this tender and such taxes and duties will be borne and paid by the contractor.
44. The contractor is supposed to abide by the minimum wages act, and shall produce all records to the Engineer-in-charge or any other statutory authority as and when called for.

The Engineer-in-charge does not hold any responsibility on account of any lapses in this regard.

45. For any clarification/ doubt, the employer/Progressive view may organize regular meetings with Contractor. The contractor shall attend such meetings invariably as and when required.
46. Management review meetings shall be held monthly or at discretion of the Engineer-in-Charge with a notice of 7 days and senior management personnel from the contractor shall be present during such meetings. Nothing extra shall be paid on this account.
47. In respect of the work of other agencies, where the commencement or progress of such work of any other agency is dependent upon the completion of particular portions of the contractor's work or generally upon the contractor maintaining progress in accordance with the approved coordinated construction program, it shall be the responsibility of the Contractor to complete such portions and maintain such progress. Should any difference arise between the contractor and the other agencies, these shall immediately be brought to the attention of the Engineer-in-Charge who after reviewing the matter(s) causing the differences will give their decision which shall be final and binding on the contractor.
48. The contractor shall have to do all drilling of holes and cutting of walls, chases or other elements of the building for the complete and proper installation of the pipe lines / ducts other equipments by using electrically operated tools such as drills / chases cutting machine etc. Manual drilling or chiseling or cutting shall be permitted on special request only. No chiseling or cutting or drilling of RCC columns, beams, girders and other principal structural members shall be done unless prior permission has been granted by the Engineer-in charge in writing.
49. All chases and openings made by the contractor for his pipe lines shall be filled / covered over with cement plaster in reasonable manner. Before rough plastering on the pipe surfaces the concealed pipes shall be secured to the wall by using proper supports / clamps.
50. After completion of work and before issuance of certificate of completion the contractor shall submit eight (8) sets to the Engineer-in-charge all the as-built drawings including layout drawing drawn at an appropriate scale and with 2 copies on CD/DVD indicating the complete PLUMBING/ SANITARY / Electrical system 'as installed', with written approval of Engineer-in-charge on the 8 sets.
51. The contractor shall prepare and produce instruction, operation and maintenance manuals with warranties and guarantees in English for the use, operation and maintenance of the supplied equipments and installations, and submit to the Engineer-in-charge in (8) copies at the time of handing over. Generally these consist of the following:
 - a. Description of the project
 - b. Operating instructions
 - c. Maintenance instructions including procedures for preventive maintenance
 - d. Manufacturer's catalogues
 - e. Spare parts list
 - f. Trouble shooting charts
 - g. Drawings

- h. Type and routine test certificates for major items
 - i. One (1) set of reproducible 'as built' drawings on appropriate material as directed by Engineer-in-Charge
 - j. Warranties and guarantees of Installed Plant and Equipment and other work like waterproofing, Anti-termite treatment of the soil
52. (i) The Contractor shall employ competent fully licensed/ qualified plumber for the work of Plumbing/ Sanitary installations in accordance with the drawings and specifications. The licensed plumber shall be available at all times at site to receive instructions from the Engineer-in-Charge in the day to day activities throughout the duration of execution of plumbing/ sanitary work.
- (ii) On completion of the Plumbing/ Sanitary installation a certificate shall be furnished by the contractor, countersigned by the licensed plumber under whose direct supervision the installation was carried out. This certificate shall be in the form as required by the Engineer-in-charge.
53. (i) The contractor shall not be provided storage/ office space for his use. The space has to be constructed/ maintained by the contractor as per his usage requirements. The contractor shall arrange to provide site office accommodation at an appropriate location for employer. Staff and Architect's Staff, along with all required good quality office furniture, as directed by Engineer-in-Charge/ Architect for which no extra payment will be made. All spaces allotted to the contractor as described above shall be vacated and all structures shall be removed from site at any time as and when required and directed by the Engineer-in-charge unconditionally and without any reservation. The Engineer-in-charge will not be obliged to give any reason for such removal. Upon receiving instructions to vacate the space, the contractor shall immediately remove all his structures, materials, etc. from the sources and clear and clean-up the site to the satisfaction of the Engineer-in-charge. It shall be the responsibility of the Contractor to safeguard the site and ensure that no illegal encroachments are made by outside elements within the area allotted to the contractor. Upon completion of the work or earlier as required by Engineer-in-Charge, the contractor shall vacate the land totally without any reservation.
- (ii) The contractor will arrange to erect, at his own cost, G.I. Sheet fencing or other approved appropriate fence around the infrastructure site, with entry/exit gates at suitable points. The contractor shall, at his own cost, provide and erect suitable fencing around the spaces allotted to him at the infrastructure sites to ensure the security of his men, materials and equipment within the sites and in relation to other contractors who will also be allotted spaces at above sites. The security of workmen, materials, equipment stores etc. within the area allotted to the contractor shall be the responsibility of the contractor.
- (iv) The contractor shall periodically take photographs / videos of site prior to commencement of work, during construction and after completion of work as suggested and shall submit the photographs / videos in soft and hard copies to employer and Architect for which no extra payment will be made. The contractor shall, apart from the above, take photographs or digital videos of critical elements as instructed by Engineer-in-Charge and submit the same for which no extra shall be payable.

(v) Site order book with numbered pages shall be kept on site. Contractor shall carry out all instructions properly and to the satisfaction of Engineer-in-Charge.

54. The Contractor(s) will have to keep on site complete survey instruments like Total Station / Theodolite / Auto Level along with full time technical personal to operate those instruments to facilitate and obtain the information required as instructed by Engineer-in-Charge and Architect, for which no extra payment will be made.
55. If required and directed by Engineer-in-Charge or Architect, contractor shall arrange visits of his personnel comprising of Engineer-in-Charge's, Architect's representative etc. to various places/ plants in or outside project town to check and verify the quality of material at manufacturer's places. No extra cost shall be given for this to contractor.
56. The site of the work shall have a full-fledged testing laboratory (of minimum 25 sq.m.) equipped with the following equipments for testing of materials, This laboratory shall be established at work site by the contractor at his own cost and nothing extra shall be payable on this account. Test report or material shall be maintained for inspection to be done by the employer at all times in the testing laboratory by the contractor. **Refer Annexure-I (Format:I-4)**
57. The number of equipments for testing shall be decided as per the quantum of work and frequency of test and contractor shall provide for the same accordingly.
58. The list of mandatory tests is as follows:

Material	Test	Relevant IS Code of testing	Field/ Laboratory Test	Minimum quantity of materials/ work out test	Frequency of testing
Sand	a) Silt content	IS:2386 part-I	Field	20 cum	Every 20 cum or part thereof or more frequently as decided by the Engineer-in-Charge.
Stone Aggregate	a) Percentage of soft or deleterious material	IS:2386 Part-II	General visual inspection, laboratory test where required by the Engineer - in-Charge		As required by Engineer-in-Charge.
	b) Particle size distribution	IS:2386 Part-I		45 Cum	For every 45cum or part thereof as decided by the Engineer-in-Charge
	c) 10% fine value	IS:2386 Part-IV	Laboratory	45 cum	Initial test and subsequent test as and when required by Engineer-in-Charge.
Cement	Slump test	IS:1199	Field	15 Cum	15 cum or part

Material	Test	Relevant IS Code of testing	Field/ Laboratory Test	Minimum quantity of materials/ work out test	Frequency of testing
Concrete, Reinforced Cement Concrete (not) leaner than M15					thereof or more frequently as required by Engineer-in-Charge.
Reinforced Cement Concrete	Cube strength	IS:456	Field	As per relevant IS Code	
Steel (if arranged by the contractor)	a) Tensile Strength b) Bend Test	IS:1608	Laboratory	As per IS Code	Every 20 tonne or part thereof confirming to IS:1786-1985
Cement (if arranged by the contractor)	a) Test for initial and Final setting Times	IS:4031	Field	10 tonne	IS:4031-1988
	b) Test of Determination of compressive strength of Cement	IS:4031	Field	50 tonne	IS:4031-1988
Bricks	Testing of Brick			As per relevant IS Code	For every 1,00,000 bricks or part thereof.
	a) Dimension	IS:1077	Laboratory/ Field	As per relevant IS Code	
	b) Water absorption & efflorescence	IS:3495	Laboratory	As per relevant IS Code	
	c) Compressive strength	IS:3495	Laboratory	As per relevant IS Code	
Brick tiles	a) Compressive strength & dimensions	IS:3495	Laboratory	50000	For every 50000 or part thereof.
	b) Water Absorption				One test for source of manufacture.

Sampling of Concrete:

The minimum frequency of sampling of concrete or each grade shall be in accordance with the following:-

Quantity of concrete in work (Cum)	Number of Samples
1-5	1
6-15	2
16-30	3
31-50	4
51 and above	4 plus one additional sample for each additional 50 cum or part thereof.

Note: At least one sample shall be taken from each shift. Where concrete is produced at continuous production unit, such as ready mixed concrete plant, frequency of sampling may be agreed upon mutually by supplier and purchasers.

59. Minimum 20% of the prescribed number of tests of the material to be used in the work shall be got tested at National Accreditation Board for Testing and Calibrating Laboratories (NABL) accredited testing laboratory at cost of the contractor, and nothing extra shall be payable on this account.
60. All the records of tests carried out shall be maintained at site by the contractor and shall be available at all times for inspection.
61. The contractor shall arrange minimum plant and equipments **as Annexure-I (Format:I-5)** at site for the execution of work. These may have to be increased depending on the requirement site.
62. The quantities indicated are for guidance only. However, it may vary to any extent and the contractor should not have any financial or other implications for such variations. The employer reserves the right to reduce the scope of work of any item if the contractor fails to deliver the works in time and the contractor shall not ask for any financial consideration for such deletion of scope of the work.
63. All fossils, coins, articles of value or antiquity and structures and other remains or things of geological or archaeological interest discovered / excavated on the Site shall, as between the Employer and the Contractor, be deemed to be the absolute property of the Employer. The Contractor shall take reasonable precautions to prevent his workmen or any other persons from removing or damaging any such article or thing and shall, immediately upon discovery thereof and before removal, acquaint the Engineer of such discovery and carry out the Engineer's instructions for dealing with the same.63. Any excavated material, as deemed fit for use in the works, shall be put to use by the contractor as instructed by the Engineer-in-Charge. All such materials used shall be deducted from the payment for works at a rate as decided by the Engineer-in-Charge.
64. All statutory approvals and sanctions from Electrical Inspectors and respective electric supply and regulatory authority for Permanent connection etc. are to be obtained by the Contractor at no extra cost. Only the official payment made in the Government treasury for deposit etc. will be reimbursed against the treasury slip.

65. All statutory approvals for Permanent Water, drainage, fire fighting, Municipal and other services are to be obtained by contractor at no extra cost. Only the official payment made in the Government treasury or to the local bodies for deposit etc. will be reimbursed against the treasury slip.
66. The contractor shall have to furnish a ROYALTY CLEARANCE CERTIFICATE from the District Collector before final bill.
67. The contractor has to get himself registered regarding the service tax with the Commissioner, Customs, Central Excise & Service Tax, Government of India as per rules applicable.
68. All statutory approvals for permanent fire NOC and other services are to be obtained by contractor at no extra cost. Only the official payment made in the Government treasury or to the local bodies for deposit etc. will be reimbursed against treasury slip.
69. Road Works
- i. The contractor shall have to produce test certificate in the Performa prescribed/ approved by BIS, from the manufacturer for every batch of steel brought to site of work.
 - ii. Top layer of B.C. Soil is to be removed up to the required level and sub grade should be compacted up to at least 97% of maximum dry density. The compaction would be done by soil compactor Vibratory rollers.
 - iii. All road works shall be carried out in accordance with MORT&H latest specifications.
 - iv. No lead will be payable for transportation of excavated materials. The excavated materials shall be spread and dressed anywhere in the campus area itself / nearby up to a distance of 5 Kms as per direction of Engineer-in-charge.
 - v. The cost of materials consumed on testing either at site or in different laboratory and the cost of testing will not be paid.
 - vi. Frequencies of the prescribed tests to be carried out must not be less than the prescribed frequencies in MORT&H latest specifications and relevant IS codes. Copies of register containing record of such tests shall be presented along with running bill. Test shall be conducted by the contractor's engineer under the supervision of the Engineer-in-charge or his authorized representatives.
 - vii. Frequent testing as desired by the Engineer-in-charge and Architect will have to be carried out at other reputed laboratory to check the quality of materials procured by the contractor at site and to check the quality of the work executed. All charges for testing shall be paid by the contractor, failing which the same shall be got done by Engineer-in-charge and charges shall be recovered from the contractor's bill at double the rates charged by the testing agency.
 - viii. All RCC pipes shall be as per the latest IS code no 458 & ISI marked pipe shall be of Socket & spigot type only. Contractor should produce the certificate in support of the same.
 - ix. Contractor shall have to submit Royalty clearance certificate for the materials consumed from the concerned authority along with the bills.

70. Special Conditions for Electrical Works

- i. The estimate and working drawings for entire electrical works is to be got approved by the contractor from concern M.P. Viduyat Vitran Co. Ltd. before execution of work. All the electrical lines and sub stations etc. i.e. Electrical works should be got installed by contractor after getting necessary shut down, if required from concern M.P. Viduyat Vitran Co. Ltd. and he has to obtain all necessary permission from state / central or other departments as and when applicable before and during the construction or execution of work.
- ii. The contractor has to maintain all safety precautions as per rules and regulations of Indian Electricity Act, M.P. Licensing Board, concern M.P. Viduyat Vitran Co. Ltd., all concerned departments of Central Government and State Government etc. The contractor shall be fully and solely responsible for the insurance of his own work, material, working staff, employee and directly or indirectly employed labourers / working and any accident or any damage caused to any person or property from / during the course of execution of the work till handing it over to concern M.P. Viduyat Vitran Co. Ltd. / Municipal COUNCIL / or other Competent Authority as applicable for the work. Any officer/employee / consultant of the employer shall not be responsible for any accident or any damage caused to any person or property for during the execution of the work till handing it over to the departments mentioned above and thereafter.
- iii. All material supplied and installed shall be of the best quality and strictly as per the approved makes only as approved by architecture, Engineer in charge. RMC reserves the right to get any or all items checked at contractor's cost from any Government Laboratory (CPRI/ NABL/ eRDA etc.) Government approved/ Private Laboratory of national or local level as required. The quality of items should be as per relevant IS specifications or described in items. The samples of all materials (as required) shall be got approved by EIC / technical committee before installation and execution of work. Samples approval / rejection on any parameter should be binding on contractor and department does not bind himself to give any reason for his decision. The contractor shall arrange testing for any parameter of material / equipments at site or at approved laboratories or at factory. No extra cost shall be paid for any expenses occurred in such testing contractor shall bear all the cost of travelling, lodging etc. of inspection team. To assure that all material installed by the contractor is genuine the contractor should purchase all material of approved make through authorized agent or representative of the manufacturers of approved make. If required by the Engineer-in-charge / Engineer (Electrical), the contractor shall show the original purchase bills and submit photo copies of these bills and the original certificate from the manufactures showing that the material supplied / installed is genuine.
- iv. The drawing which may be issued with the tender are diagrammatic and indicative to the arrangement of various components of the Systems and to the extent of work. But the actual work to be carried out will be as per the approved working drawings which can vary to any extent. The quantities given in the tender may vary

and some items may not be used at all depending on work conditions and / or concern M.P. Viduyat Vitran Co. Ltd. requirements and the contractor shall have no claim on this account.

- v. Contractor has to prepare detailed working drawings, shop drawings, fabrication drawings based on the basic of General Arrangement drawings / guidelines as per the relevant Standards, specifications site / situations rules and laws and he will get prior approval for these drawing from Competent Authorities / departments and Engineer-in-charge before starting the work. After approval, contractor shall make the requisite changes as suggested and submit the final execution drawing in six copies will be returned to him for execution duly signed by EIC & Consultant. No. extra cost shall be given for this to the contractor.
- vi. On the completion of the work the contractor shall supply completion drawing in 3 copies with original tracing. A soft copy of completion drawings (on AutoCAD) shall also be provided by the contractor. All test reports of the internal and external electrification installation in three copies shall be handed over to engineer in-charge in good condition by the contractor before finalization of his final bill. The contractor shall supply all above items free of cost.
- vii. After completion of the entire work, test report should be submitted to the Competent Authorities of concern M.P. Viduyat Vitran Co. Ltd. and M.P. Licensing Board and also to the Engineer in Charge and NOC is to be obtained from M.P. Licensing Board and submitted to the Competent Authorities of concern M.P. Viduyat Vitran Co. Ltd. and M.C Necessary charges (Government Fees) will be paid by M.C for charging of work.

The contractor has to get the entire electrical work charged and the entire external electrification work including the lighting installation should be handed over to concern M.P. Viduyat Vitran Co. Ltd. / Municipal COUNCIL / or other Competent Authority as applicable in this matter as per the instructions of the Engineer in Charge.

During the maintenance period the contractor / agency have to carry out all necessary repairs within required period looking to the urgency of work as decided by engineer in- charge. The maximum limit, if allowed by engineer-in-charge, shall be 3 days of receipt of such communication from Engineer-in-charge. If defects & damages are not rectified to full satisfaction of engineer-in-charge within time limit, then department reserves right to get the work done by any outside agency & amount paid for such works will be recovered from the amount deposited by contractor / agency against Performance & Maintenance Security & Security Deposit etc.

Handing over formalities must be done by agency / contractor immediately after completion of work along with charging of line and if any bonfires intention of delay is observed n that case department reserves the right to with hold/ encases security of the contractor / agency and no separate advance notice to this respect shall be necessary.

- 71. Special conditions as mentioned above shall supersede the relevant clause(s) of the NIT, conditions of contract and relevant condition(s) of relevant SOR.

LIST OF APPROVED BRANDS AND MAKE OF CIVIL WORK

S. NO.	ITEM	MAKE
01.	Grey Cement	Ultratech, ACC, JK or equivalent make as approved by EIC and Architect.
02.	White Cement	JK, Birla or equivalent make as approved by EIC and Architect.
03.	HRC-TMT Reinforcement Bars – High Corrosion Resistant, Thermo Mechanically Tested (TMT) Hot Rolled Deformed Bars	Conforming to IS and TISCO, SAIL, RINL make or equivalent make as approved by EIC and Architect.
04.	Concrete Additive	FOSROC, CICO-TL, SIKA or equivalent make as approved by EIC and Architect.
13.	All Paint, primer, oil bound distemper & synthetic enamel	Asian, ICI, Nerolac or equivalent make as approved by EIC and Architect.
20.	Bricks	Best Quality Open Bhatta Bricks as approved by EIC.
21.	Sand	Narmada Sand as approved by EIC.
22.	Aggregate	Best quality locally available obtained from cone crusher as approved by EIC.
32.	Colour coated sheet	As approved by EIC and Architect
33.	GI Pipes	TATA, JINDAL or Approved Equivalent
34.	CPVC Pipes / Fittings	ASTRAL or equivalent make as approved by EIC and Architect.
35.	PVC Pipes / Fittings	Finolex, Prince, Suprime or equivalent make as approved by EIC and Architect.
36.	CI Pipes	As approved by EIC and Architect.
37.	Nahai Trap PVC	Finolex or equivalent make as approved by EIC and Architect.
38.	SS Pipe 304 grade	As approved by EIC and Architect.

NOTE: This is a general indicative list of the materials for the brand and make of the material to be used by the contractor. The specification mentioned in the Schedule of Quantities shall take precedence. However, the contractor shall take approval of Architect and EIC regarding the make and type of each material before execution. The Architect and EIC's decision regarding the use of material mentioned above or mentioned in Schedule of Quantities or equivalent will be final and binding on the contractor. In case contractor wishes an alternative other than suggested by Architect, equivalent to those listed above or mentioned in Schedule of Quantities for economy and better quality, the name shall be submitted to Architect and EIC giving detailed specification, catalogue, price list along with the samples for approval from the Architect. All the necessary test shall be carried out at no extra cost and report be submitted to EIC and Architect. The Architect and EIC reserve the right to permit or nor permit the contractor for use of other alternate without any reasons and contractor is bound to follow the decision of the EIC and Architect in this regard.

LIST OF APPROVED MAKES FOR ELECTRICAL

S. NO.	ITEM DESCRIPTION	MAKES
01	Distribution Transformer, Star Rating	ABB, Tesla Transformer, Voltamp, Schneider
02	Power Transformer	BHEL, Crompton Greaves, ABB, Schneider
03	Vacuum Circuit Breaker, SF-6/Gas filled Circuit Breaker	ABB, Schneider, Siemens, crompton
04	ACB	ABB, Schneider, Siemens
05	PSS/CSS with HT/LT Switch Gear, Transformer and connected accessories	ABB, Schneider, Siemens, L&T
06	MCCB, MCB, ELCB, RCCB, DB, ICTPN, TP, HRC Fuse, Change over Switch, Switch Fuse Unit	ABB, Schneider, Siemens, L&T
07	XLPE Cable 11/33kV grade	CCI, Gloster, Finolex, Ravin cable
08	PVC/XLPE Power Cables up to 1.1kV grade	CCI, Gloster, Universal, Ravin cable
09	Instrument Voltmeter, Ammeter, PF meter	Schneider, Automatic Electric, Siemens, HPL
10	33/11kV Cable End Termination & Jointing Kits	Raychem, 3M, Mahendra
11	Relays	Siemens, Schneider, C&S
12	Lighting Fixtures	Phillips, Schreder, Crompton Greaves, Wipro CleanRay, GE
13	PVC insulated Elect. Wires Sheathed/ unsheathed, PVC flexible LT cable, multicore, single core, Flat cable for submersible pumps	Finolex, RR cable, HPL
14	Current Transformer	Schneider, Automatic Electric, Siemens, HPL
15	On line UPS, Servo Stabilizer, Inverter, CVT	APC, TATA Libert
16	Rotary Switches, Selector Switches	Kaycee, Siemens, Schneider
17	Exhaust fan/ Air Circulator/ Bracket & Pedestal fans/ Ceiling fan	Crompton Greaves, Polar
18	Electronic Energy Meter	Secure, ABB, Schneider
19	Capacitors- PF correction for Electrical General Services	BHEL, ABB, Schneider, EPCOS
20	DG Sets - Portable	Birla Yamaha, CGL, Shriram Honda,
21	DG Engine	Cummins, Kirloskar, Caterpillar, Ashok Leylend, Penta-Volvo
22	Alternator for DG set	KEC, CGL, Stampford, Leroy-Somer, Kirloskar-Green

23	LT Switchgear & control gears- Contactors & motor starters, Energy Efficient Soft Starter panel/ Earthing Switch, Single phase preventer	ABB, Siemens, Schneider,C&S
24	Timers - Electronic Solid State	ABB, Siemens, Schneider
25	Water Coolers	Blue Star, Fedders, Kelvinator, Shriram, Sidwal, Voltas
26	Electrical Accessories (Piano Switch, Plugs & Sockets, Ceiling Rose, Angle Holder, Holders)	Legrand, Schneider, Havells
27	Bell Buzzer	Schneider
28	Electronic Fan Regulator	Crompton Greaves
29	GI/MS Pipe	TATA, Jindal, TT Swastik, Prakash Surya
30	Geysers	Crompton Greaves, Recold
31	Lifts & Escalators	OTIS, ThyssenKrupp, Shindler, KONE, Mitsubishi.
32	Solar Water Heaters	As per MNES approved sources.
33	Solar Distilled Water Plants	Makes can be approved on the recommendation of divisions.
34	Battery Charger for battery room	Amar Raja, Exide, RS Power
35	PVC Conduit pipe & Casing capping for electrical wiring	A.K.G., Polycab, BEC
36	Aluminum Ladders	Sumer, Beatfire
37	LT Panels	From CPRI tested firms.
38	Air Curtain	Aircon, ALMONARD, CGL
39	Early Streamer Emission Lightning Conductor Air Terminal (ESELCE)	Ingesco (Spain)
40	33 KV Air break switch	Atlas (Bomay)
41	33 KV LA	Elpro, CGL
42	33 KV Drop out fuse	Atlas (Bomay)
43	Control and Relay Panel	ABB, AREVA, Schneider, Siemens
44	Batteries	Exide, Amco, Amar Raja, HBL Nife
45	Battery Charger	Chhabi, HBL, Caldine, Masstech, DUBAS, Statcon
46	Fire Protection System	Vijay, Unitech, Technofab, Mather & Platt, Steelage.
47	Wires - Copper Type	Finolex, RR
48	Telephone Wire	Finolex, Indoplast, RR, Delton
49	Telephone Cable	Finolex, Delton, Nicco, Indoplast, RR

50	Wall Brackets, Ceiling Light, Bollard	Philips, Wipro, Schredder
51	Coaxial TV Cable	Finolex, Havells, American North Star, RR
52	Octagonal Pole	Philips, Wipro, Schredder
53	Pump	KSB, Kirloskar, Grundfos
54	Advance Lightening System	Indelec, LPI, Ingesco

NOTE:-

This is a general indicative list of the material for the brand and make of the material to be used by the contractor. The specification mentioned in the Schedule of Quantities shall take precedence. However the contractor shall take approval of Architect and EIC regarding the make and type of each material before execution. The Architect and EIC decision regarding the use of material mentioned above or mentioned in Schedule of Quantities or equivalent will be final and binding on the contractor. In case contractor wishes an alternative other than suggested by Architect, equivalent to those listed above or mentioned in Schedule of Quantities for economy and better quality, the name shall be submitted to Architect and EIC giving detailed specification, catalogue, price list along with the samples for approval from the Architect. All the necessary test shall be carried out at no extra cost and report be submitted to EIC and Architect. The Architect and EIC reserve the right to permit or not permit the contractor for use of other alternate without any reasons and contractor is bound to follow the decision of the EIC and Architect in this regard.

- . 1 PAINT : ASIAN/BURGER
- 2 G M Valves : AUDCO / KOR VALVE/ZOLOTO
ESAB 28/ ADVANI/ADOR/MANGLAM
3. WELDING ELECTRODES :
. : DUNLOP/Approved quality and make.

B.

struts [S.O.R.N.5.9.6/P.66]	24.00	Sqm	205	4872.00
C) Lintels, beams, girders, bressumers and cantilevers, [S.O.R.N.5.9.5/P.66]	60.15		216	12992.40

Sr.	Particulars	Qty	Unit
1	Earth work in excavation/ by mechanical means (Hydraulic Excavator)/ manual means over areas (exceeding 30 cm in depth, 1.5m in width as well as 10 sqm on plan) including dressing of sides and ramming of bottom disposal of excavated earth, lead upto 50 m and lift upto 1.5 m, disposed earth to be levelled and neatly dressed.[S.O.R.N. 2.7.1 /P.22] Ordinary rock	18	Cum
2	EXTRA FOR ADDITONAL LIFT Extra for additional lift of 1.5 M. or part there of in soils [S.O.R.N. 2.26.1 /P.26]	18	Cum
3	P.C.C. Providing and laying in position cement concrete of specified grade excluding the cost of centering and shuttering - All work up to plinth level : [S.O.R.N. 4.1.2.2/P.45] Nominal Mix -1 Cement : 3 sand : 6 graded stone aggregate (M 10)	1.80	Cum
4	R.C.C. a) Below Plinth Providing and laying in position specified grade of reinforced cement concrete (with 20mm nominal size graded stone aggregate) excluding the cost of centering, shuttering, finishing and reinforcement - All work up to plinth level : [S.O.R.N. 5.1.2/P.65]	4.01	Cum
	b) Above Plinth Reinforced cement concrete work (with 20mm nominal size graded stone aggregate) in beams, suspended floors, roofs having slope of any degree landings, balconies, shelves, chajjas, lintels, bands, plain window sills, staircases and spiral stair cases above plinth level and up to floor two level excluding the cost of centering, shuttering, finishing and reinforcement in concrete grade (b) M 20 –Grade Concrete. 5.4.1 M 20 –Grade Concrete	6.49	Cum
5	STEEL Reinforcement for R.C.C. work including straightening, cutting, bending, placing in position and binding including cost of binding wire up to floor two level including all wastage etc. complete.[S.O.R.N.5.16.4/P.68] Hot rolled deformed bars	840.54	Kg
6	FORM WORK Centering and shuttering including strutting, propping etc. and removal of form for.[S.O.R.N.5.9/P.66] (a) Foundations, footings, bases of columns, etc. for mass concrete up to plinth level..[S.O.R.N.5.9.1/P.66]	24.72	Sqm
	B) Columns, pillars piers, Abutments, post and struts.[S.O.R.N.5.9.6/P.66]	24	Sqm
	C) Lintels, beams, girders, bressumers and cantilevers,.[S.O.R.N.5.9.5/P.66]	60.15	sqm
7	Filling by available excavate dearth (excluding rock) intranches, plinth, sides of foundations etc. in layers not exceeding 20 cm in depth, consolidating each deposited layer by ramming and watering, lead upto 50m and lift upto 1.5 m. [S.O.R.N. 2.25 /P.19]	28.60	Cum
8	PLASTER		
	a) 20 mm cement plaster of mix :13.3.3 -- 1:6 (1 cement: 6 fine sand) [S.O.R.N.13.3.3/[c]/P.156]	30.96	Sqm
	© PLASTER 6mm cement plaster of mix :-1:4 (1 cement : 4 sand) [S.O.R.N. 13.8.1 /P.245]	17.1	sQM
9	Steel work in built up tubular trusses including cutting, hoisting fixing in position and applying a priming coat of approved steel primer, welded and bolted including special shaped washers etc. complete [S.O.R.N.10.16/P.115]	6300	kg

10	Providing and fixing SS of required pattern in frames of windows etc. with M.S. flats, square or round bars etc. all complete	200	Kg
11	Providing and fixing pre-coated galvanised iron profile sheets (size, shape and pitch of corrugation as approved by Engineer-in-charge) 0.50 mm + 0.05 %, total coated thickness with zinc coating 120 gsm as per IS: 277 in 240 mpa steel grade, 5-7 microns epoxy primer on both side of the sheet and polyester top coat 15-18 microns. Sheet should have protective guard film of 25 microns minimum to avoid scratches while transportation and should be supplied in single length upto 12 metre or as desired by Engineer-in-charge. The sheet shall be fixed using self drilling /self tapping screws of size (5.5x 55mm) with EPDM seal, complete upto any pitch in horizontal/ vertical or curved surfaces excluding the cost of purlins, rafters and trusses and including cutting to size and shape wherever required. [S.O.R.N.12.15.1/P.221]	108	Sqm
12	Providing and fixing pre-coated galvanised steel sheet roofing accessories 0.50 mm + 0.05 % total coated thickness, Zinc coating 120gsm as per IS: 277 in 240 mpa steel grade, 5-7 microns epoxy primer on both side of the sheet and polyester top coat 15-18 microns using self drilling/ self tapping screws complete : Ridges plain (500 - 600mm). [S.O.R.N. 12.51.1 /P.221]	10	RM
13	Providing and fixing 15 cm wide 45 cm over all semi circular plain G.S.sheet gutter with iron brackets 40x3mm size, bolts, nuts and washers etc.including making necessary connections with rain water pipes complete.0.80mm thick with zinc coating not less than 275gm/m ² [S.O.R.N.12.7.1. /P.221]	20	RM
14	Providing and fixing on wall face Unplasticised Rigid PVC rain water pipes conforming to IS : 13592 Type A including jointing with seal ring conforming to IS : 5382 leaving 10 mm gap for thermal expansion. (i) Single socketed pipes .110 mm diameter (minimum wall thickness 2.2mm)S.O.R.N.12.32/P 224	32	RM

SECTION 5
AGREEMENT FORM
AGREEMENT

This agreement, made on the _____ day of _____ between _____ (name and address of Employer) (hereinafter called "the Employer") and _____ (name and address of contractor) hereinafter called "the Contractor" of the other part.

Whereas the Employer is desirous that the Contractor execute _____ (name and identification number of Contract) (hereinafter called "the Works") and the Employer has accepted the Bid by the Contractor for the execution and completion of such Works and the remedying of any defects therein, at a cost of Rs. _____

NOW THIS AGREEMENT WITNESSED as follows:

1. In this Agreement, words and expression shall have the same meanings as are respectively assigned to them in the conditions of contract hereinafter referred to and they shall be deemed to form and be read and construed as part of this Agreement.
2. In consideration of the payments to be made by the Employer to the Contractor as hereinafter mentioned, the Contractor hereby covenants with the Employer to execute and complete the Works and remedy any defects therein in conformity in all aspects with the provisions of the contract.
3. The Employer hereby covenants to pay the Contractor in consideration of the execution and completion of the Works and the remedying the defects wherein Contract Price or such other sum as may become payable under the provisions of the Contract at the times and in the manner prescribed by the Contract.
4. The following documents shall be deemed to form and be ready and construed as part of this Agreement viz.
 - i. Letter of Acceptance
 - ii. Contractor's Bid
 - iii. Condition of Contract: General and Special
 - iv. Contract Data
 - v. Bid Data
 - vi. Drawings
 - vii. Bill of Quantities and
 - viii. Any other documents listed in the Contract Data as forming part of the Contract.

In witnessed whereof the parties there to have caused this Agreement to be executed the day and year first before written.

The Common Seal of _____ was hereunto affixed in the presence of:

Signed, Sealed and Delivered by the _____ said _____ in the presence of:

Binding Signature of Employer _____

Binding Signature of Contractor _____